

Calibration System

Julien Guy,
Sonia Karkar,
Laurent Le Guillou

(CNRS/IN2P3/LPNHE)

DESI Spectrograph FDR
March 15-16, 2016



Dark Energy Spectroscopic Instrument

U.S. Department of Energy Office of Science
Lawrence Berkeley National Laboratory

Calibration System

has two main sub-assemblies

Dome Flat Screen

Screen used to project light onto
Modification of current screen

Calibration Lamps

4 sets of lamps

Spectrographs

10 Identical 3 channel spectrographs
In large Coude room

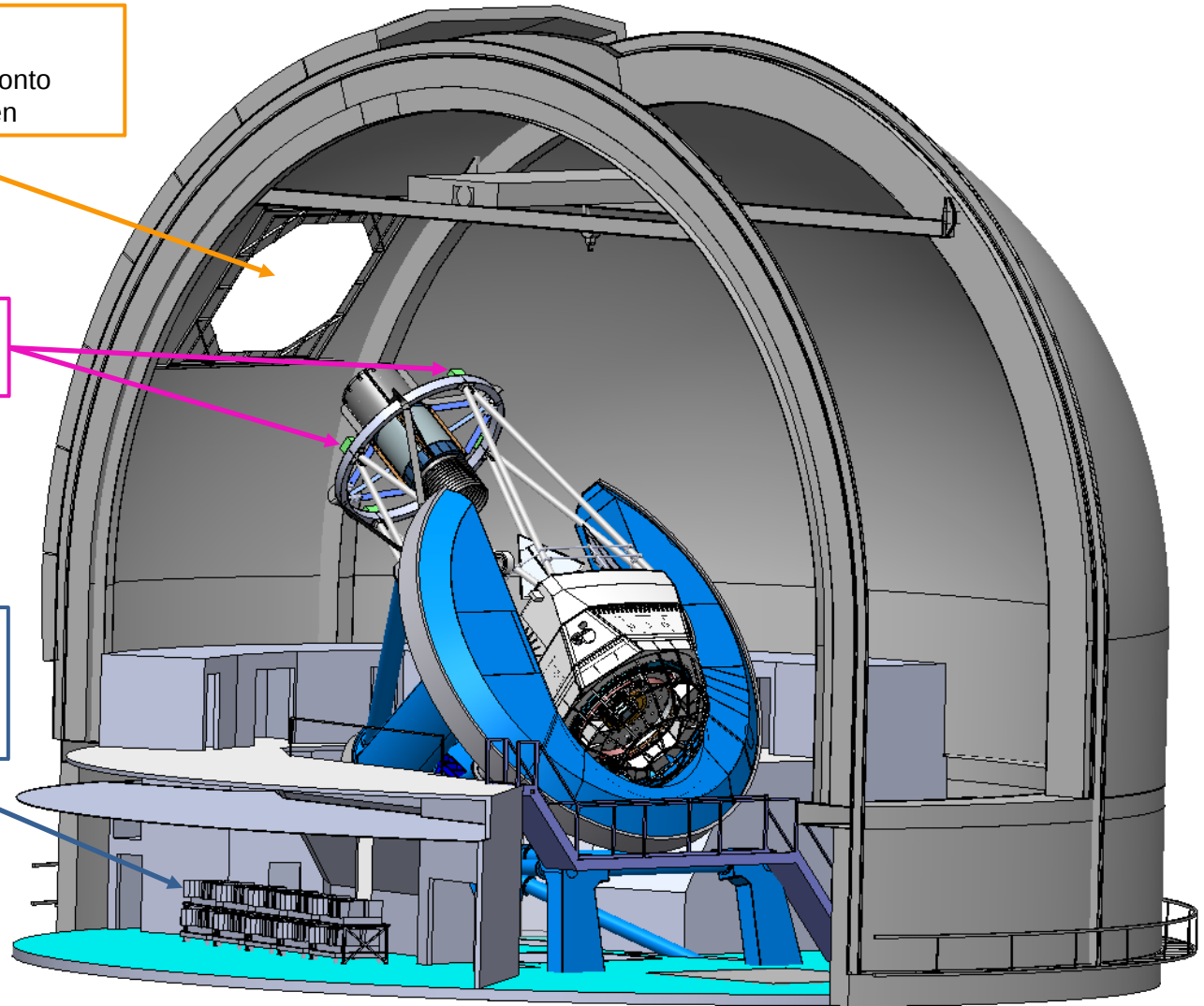

Dark Energy Spectroscopic Instrument

U.S. Department of Energy Office of Science
Lawrence Berkeley National Laboratory

Design baseline overview

- 4 illumination boxes
 - Set of lamps :
 - 1 continuum lamp, halogen, tunable intensity
 - 3 different spectral lamps, prob. not tunable
 - Power supply, control hardware
- Screen
 - Permaflect coated panels
 - Mounted on existing frame



Planning early phase : 2016 Q1&2

- Initial project task list and (retro)planning ✓
- Requirements update ✓
- Lamps:
 - Derive specifications from requirement ✓
 - Explore models options : *On going*
 - Buy and test lamps
 - Control system hardware and software
 - Detail design of boxes
- Screen:
 - Derive specification from requirement ✓
 - Get quotes for re-coating and new panels



Requirements update (DESI-1067 v2)

| Req't Name | Requirement | Rationale | Verification method |
|------------------------|--|---|--|
| Bandpass | 360-980 nm | Required for z range of Ly-alpha QSOs and ELGs (DESI-0318) | Laboratory tests: measure lines lamps spectrum |
| Pupil Uniformity | 20% (azimuthally averaged) | PSF stability of 3% req. IN.FBR-5013, (DESI-0581 v8) | Measured lamp luminance plus analysis |
| Field Uniformity | 5% (relative to the telescope field response to a constant sky intensity) | ELG redshift efficiency and catastrophic failure rate unchanged | Measured lamp luminance plus analysis |
| Spectral Line Coverage | Wavelength calibration precision better than 0.15 pixel or 0.08 A (this requires "approximately" a max. bright line separation of 40 nm) | Required for accurate spectral extraction. (DESI-318) | Laboratory tests: measure lines lamps spectrum |
| Continuum flatness | Maximal spectral variation of a factor 10 (max/min) in counts | Calibration images above noise and below non-linear regime & brighter-fatter effect | Laboratory tests: measure continuum lamps spectrum |



Dark Energy Spectroscopic Instrument

U.S. Department of Energy Office of Science
Lawrence Berkeley National Laboratory

Requirement rationale

Bandpass: 360-980 nm

Bandpass of the calibration system is defined by the DESI bandpass

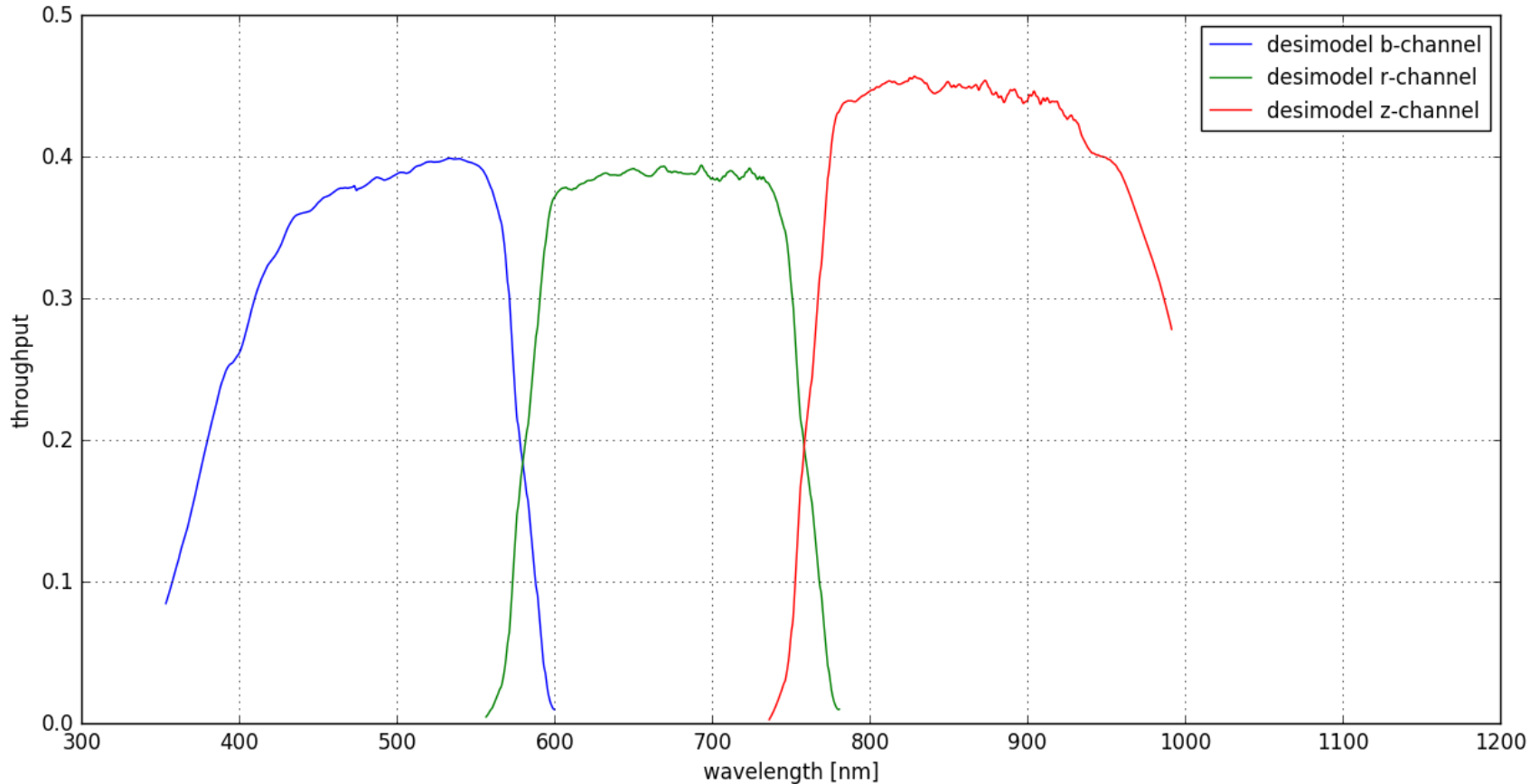

Product of the Telescope to Fiber Input, Fiber System and Spectrograph Throughputs

The curves are obtained with desimodel version 0.4.



Dark Energy Spectroscopic Instrument

U.S. Department of Energy Office of Science
Lawrence Berkeley National Laboratory

Requirement rationale

Pupil uniformity: 20%

Pupil uniformity change of 20% → max change of spectro PSF FWHM < 0.2% $\forall \lambda$

Meets requirement on PSF stability of 3% (requirement IN.FBR-5013, see DESI-0581 (v8)).

Full uniformity study by P.Jelinsky

- Light intensity on the screen
→ angular distribution into the fibers
- The fiber scrambles the light azimuthally and blurs it slightly radially due to Focal Ratio Degradation (FRD)
- Changing angular distribution fiber output fiber
→ small effect on spectro PSF

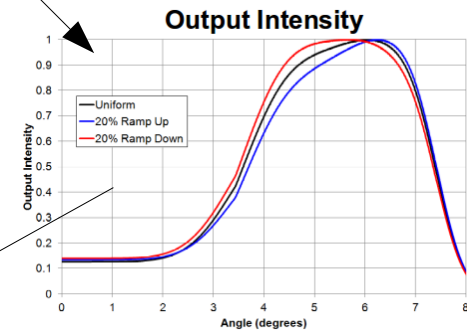
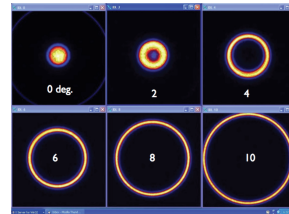
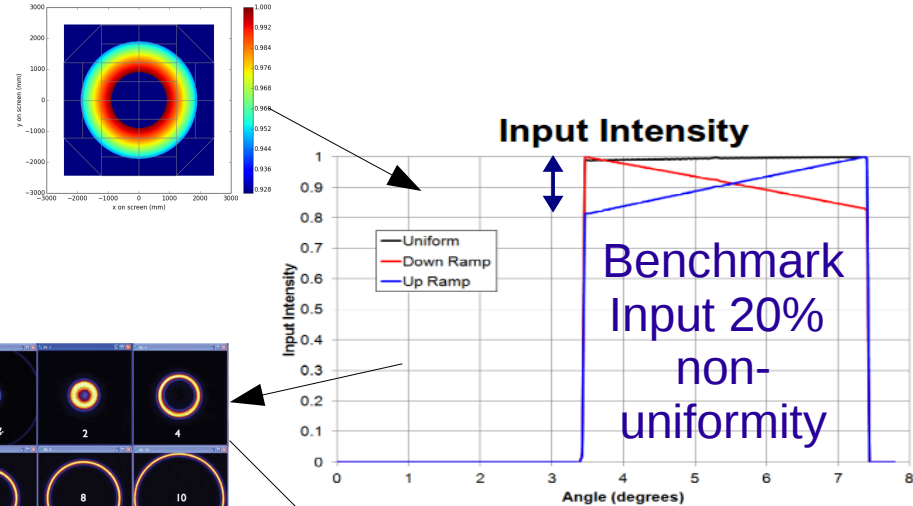

max change of spectro PSF FWHM < 0.2% $\forall \lambda$ << 3%



Requirement rationale

Field uniformity: 5%

Field inhomogeneities :

- error on the fiber flat-fielding (calibration with continuum lamps)
 - sky background residuals in the target spectra
 - Science criteria : ELG redshift efficiency and catastrophic failure rate

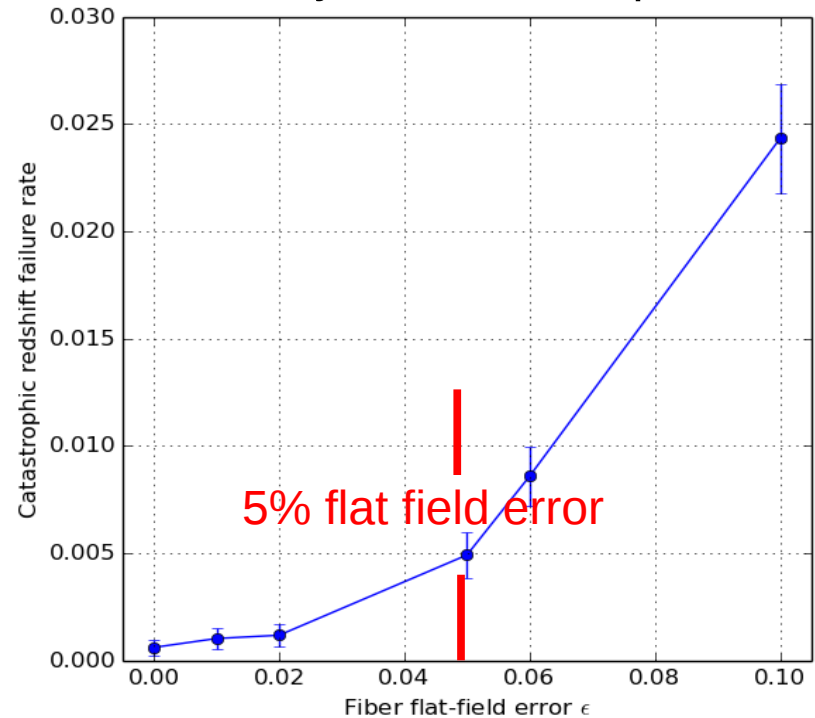
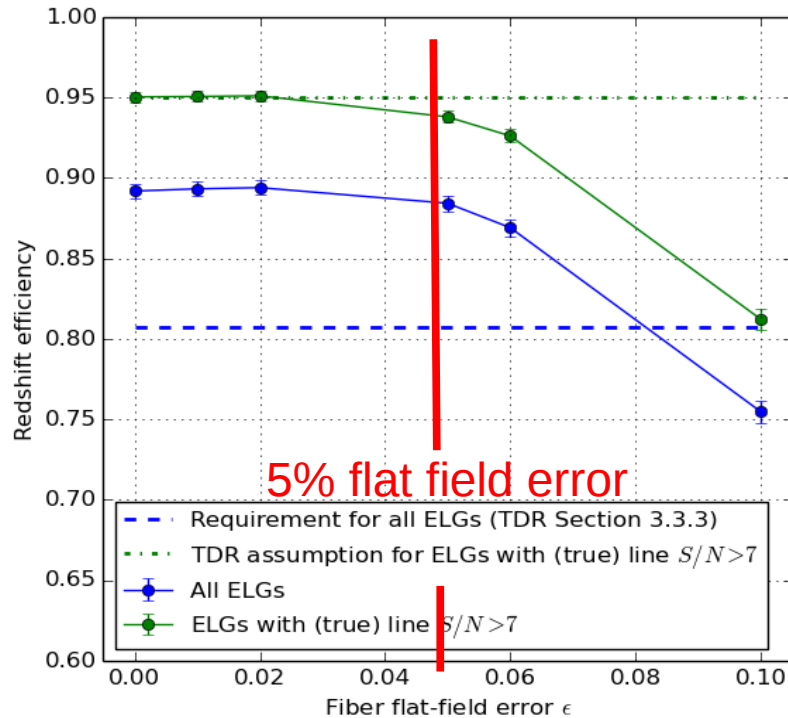

The simulated ELG sample of the first redshift data challenge were fit with the zstarp redshift fitter, with a fiber flat field error emulated by adding a fraction of the sky spectrum in the ELG spectra



Dark Energy Spectroscopic Instrument

U.S. Department of Energy Office of Science
Lawrence Berkeley National Laboratory

Requirement rationale

Spectral Lines coverage

- Impact wavelength solution
 - Rough estimate with MC gives 40 nm spacing
 - Example with third pipeline data challenge (DC3) of DESI and SDSS/BOSS lines :

Compare precision of wavelength solution with lines coverage

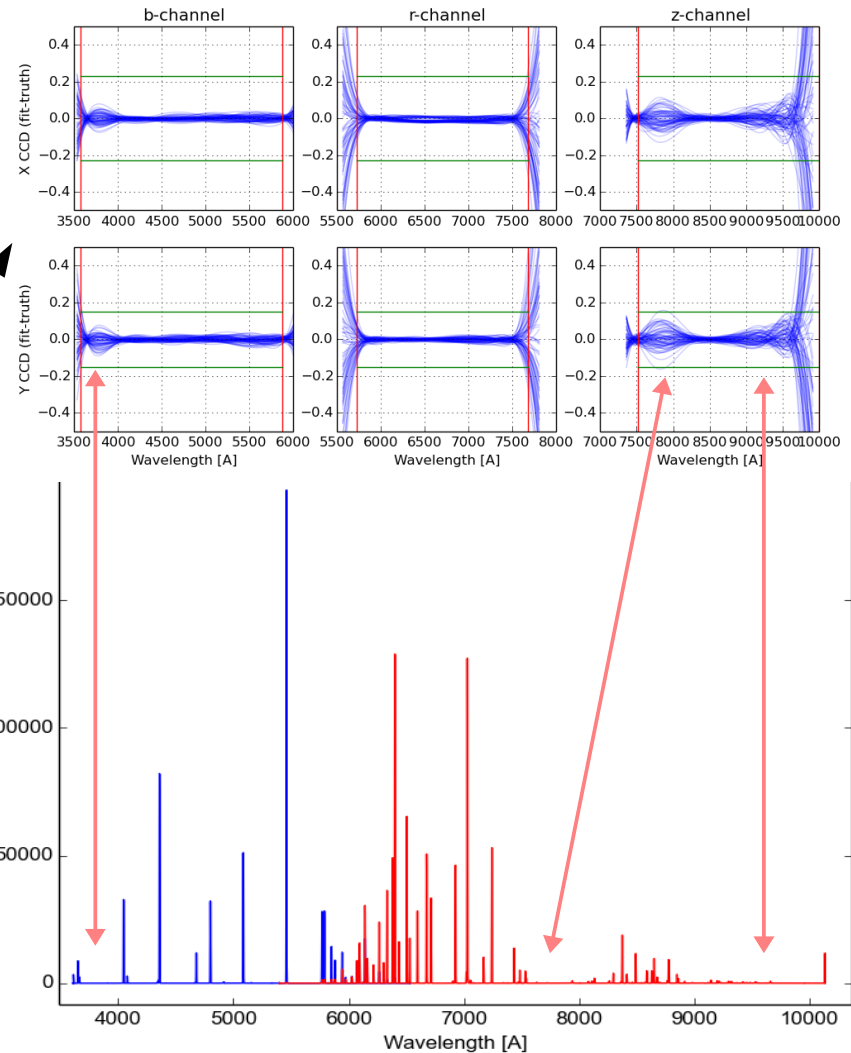

Requirement rationale

Continuum flatness

- Clean calibration signal above noise
 - Min number of electron per pixel row : 10 000 e⁻
- Avoid high intensity non-linear effects
 - Max number of electron per pixel row : 168 000 e⁻
- Ratio of DESI throughput across full spectral range = 5
 - Max ratio of counts across the spectrograph complete spectral range = 3
very constraining
 - Becomes factor of 10 if use several exposures
with different exposure time for each band



Picture of the current continuum lamps available at the Mayall
“low flux” lamps have a blue filter to balance their spectrum.

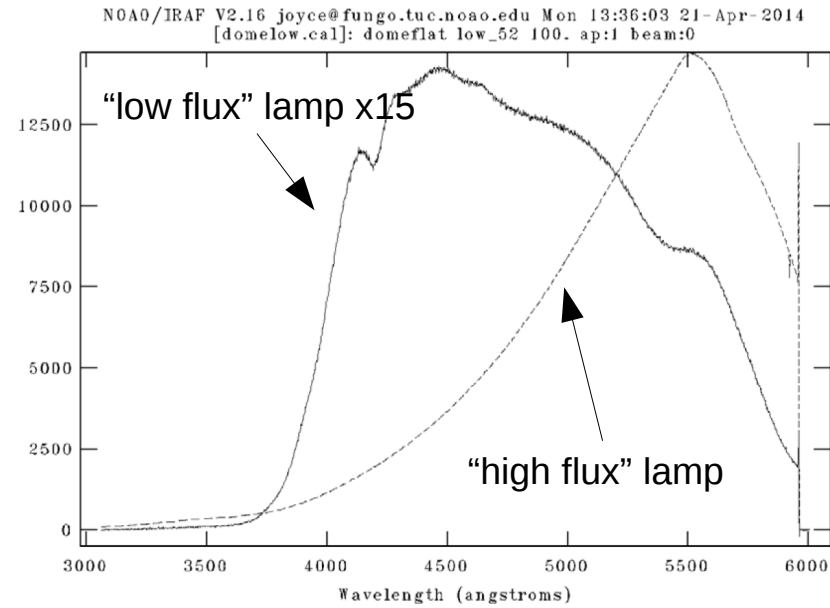

Dark Energy Spectroscopic Instrument

U.S. Department of Energy Office of Science
Lawrence Berkeley National Laboratory

From requirements to specifications:

Uniformity

- First study by P. Jelinsky, using ray tracing ✓
 - Define need for 4 sets of lamps
 - Careful analysis of fiber to fiber uniformity
- New code, purely geometrical, interfaced with DESI model
 - Reproduce previous results ✓
 - Investigate effect of intensity variation of lamps *On going*

Screen illumination

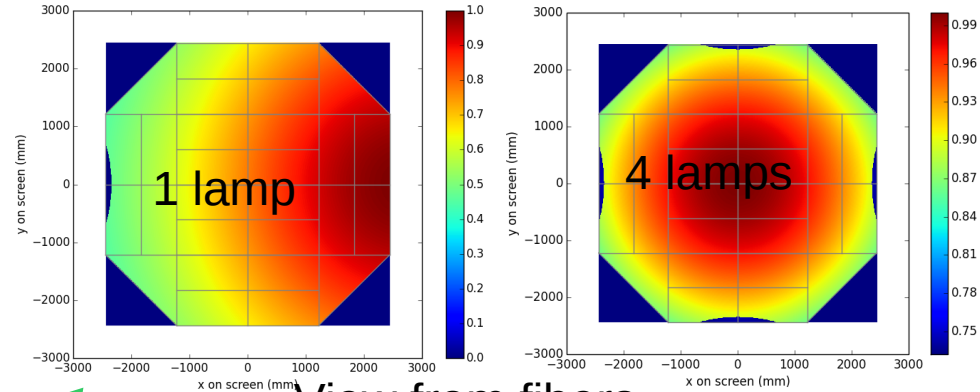

View from fibers

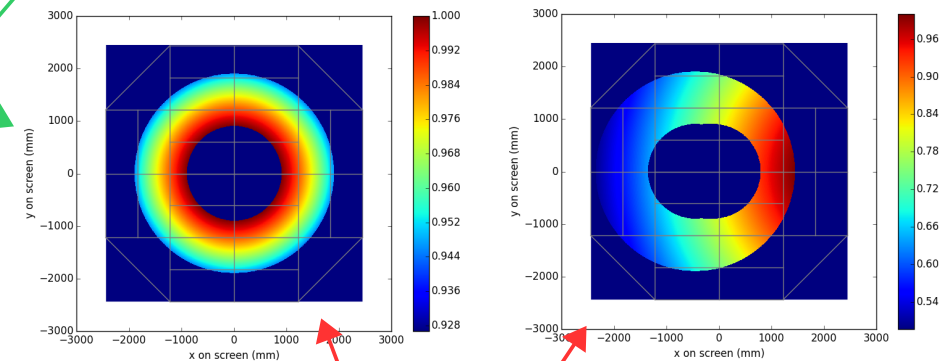

At focal plane center

1.6 deg off center

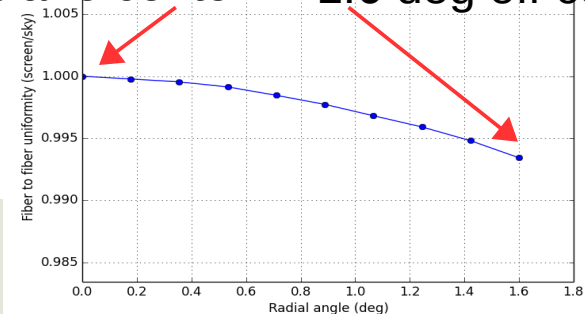

From requirements to specifications:

Spectral coverage

- Gather lamps spectrum data from manufacturer *On going*

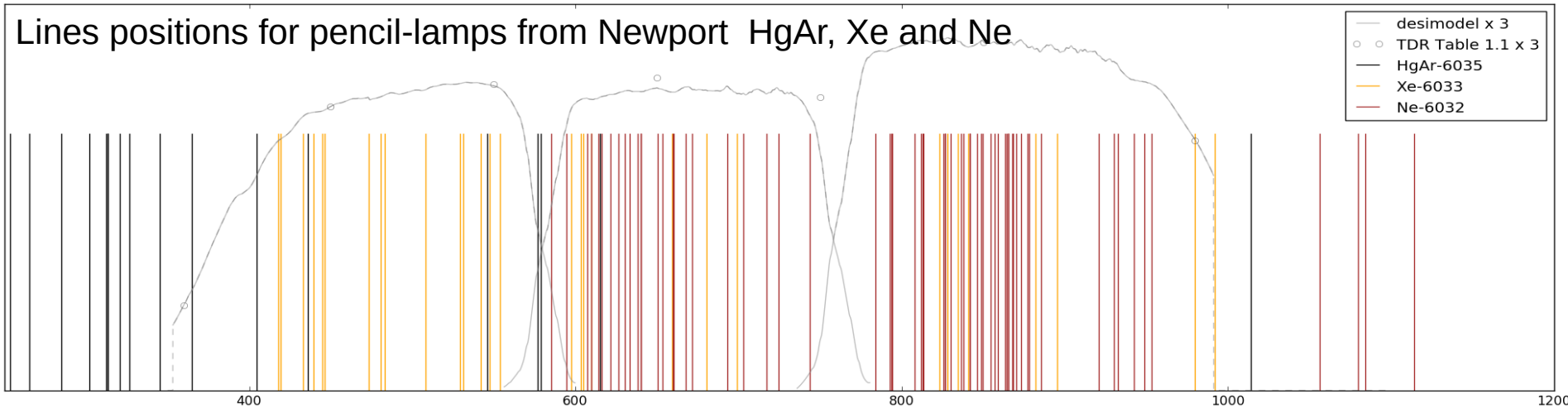
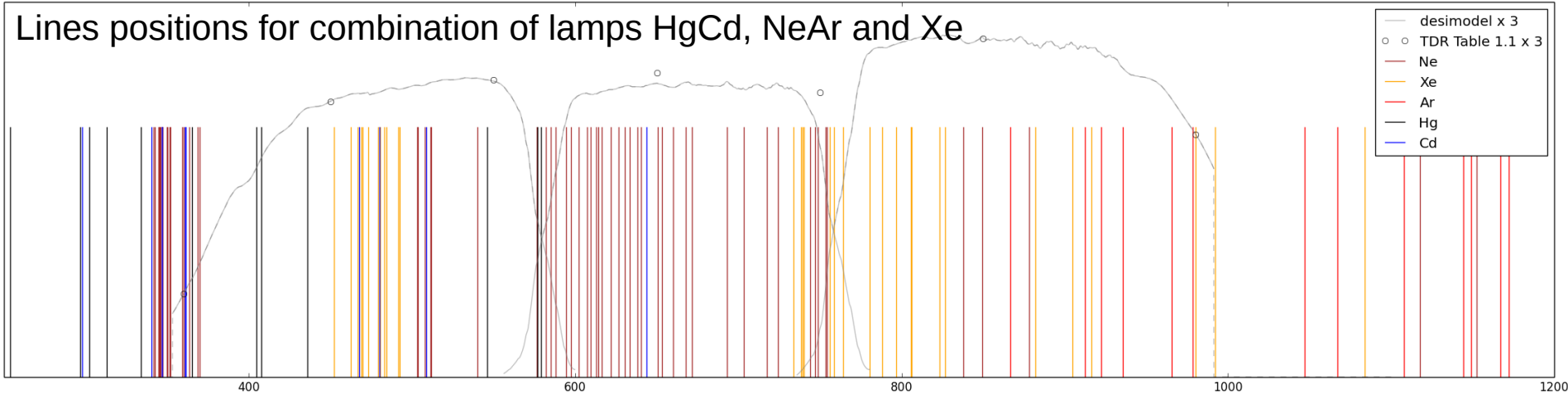

Dark Energy Spectroscopic Instrument

U.S. Department of Energy Office of Science
Lawrence Berkeley National Laboratory

From requirements to specifications:

Spectral coverage

Use new code+DESI model to estimate expected flux and spectrum of lamps

On going

Lines positions and intensities integrated on λ

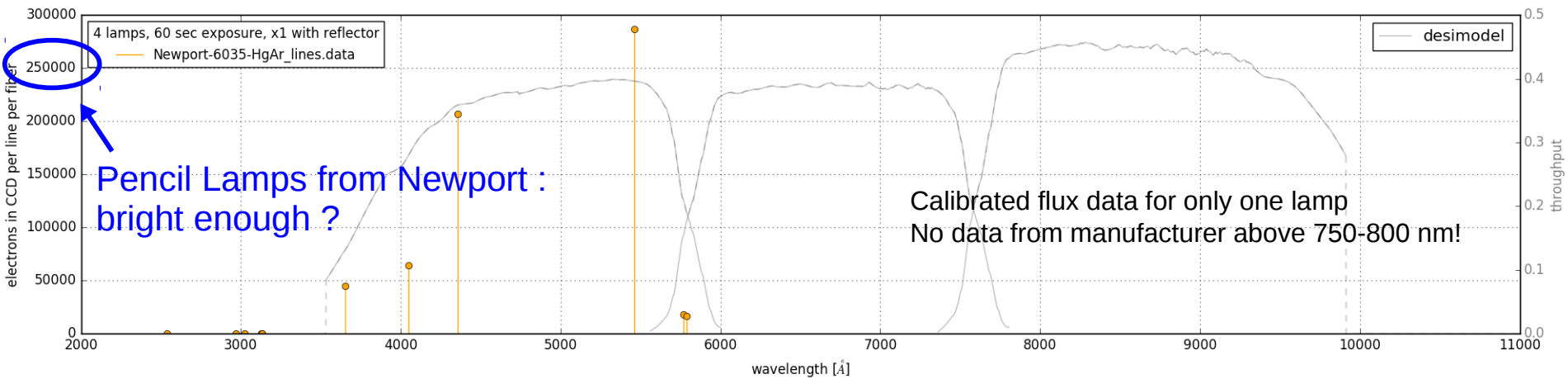
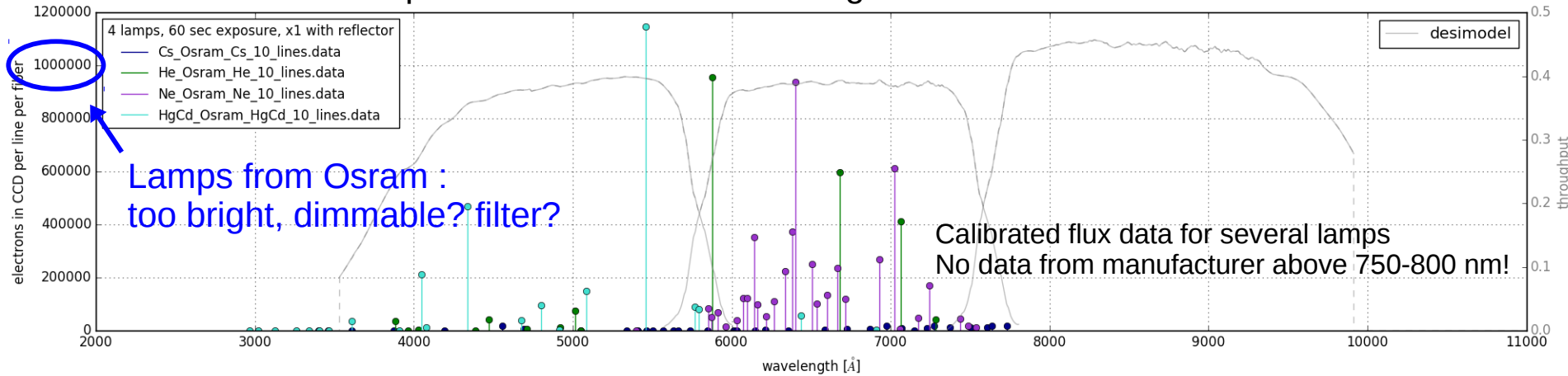

Dark Energy Spectroscopic Instrument

U.S. Department of Energy Office of Science
Lawrence Berkeley National Laboratory

Lamps

- Spectral Lamps :
 - Looking for a good combination for spectral coverage
 - Low-pressure gas discharge lamps
 - Intensity adapted to DESI illumination system
 - Appropriate to be embedded on upper ring (size/weight)
 - Proper angular coverage toward the screen (or add optics)
 - So far mainly two suppliers considered :
 - OSRAM bulbs
 - A lot of models available
 - Need to provide adapted power supply (~1A per lamp, 10 to 60 V depending on model)
 - Too bright?
 - Newport pencil-lamps
 - Power supply provided (6 to 20 mA per lamp)
 - Bright enough?
 - Spectral coverage?
- Continuum lamps:
 - Most probably halogen lamps ~50W
 - Model with enhanced flux in blue and/or blue filter

Data from manufacturer are very sparse so we plan to buy and test lamps in lab before definitive choice



Lamps control

- Continuum lamps
 - Intensity controllable via existing system (TCS)
- Spectral lamps
 - Probably only ON/OFF commands
 - Calibration System controller to be interfaced with TCS
 - ICD : DESI-doc 559
- Investigate temperature monitoring for safety issue

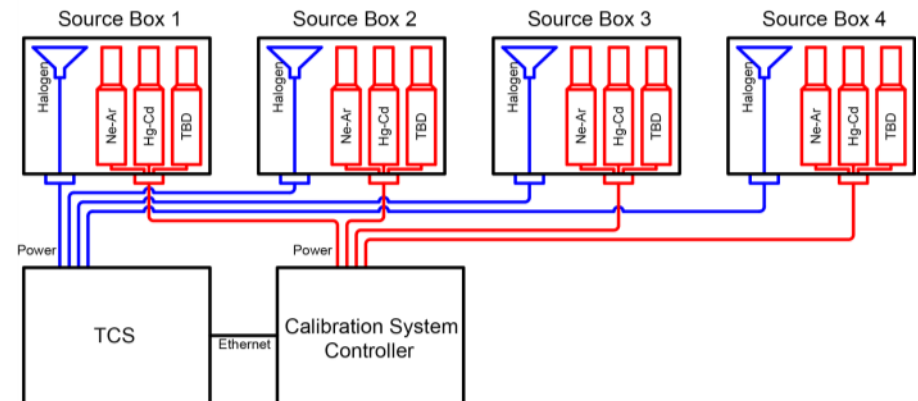

Lamps boxes

- The boxes contain the lamps, their power supply and the control hardware
- Aim for 50W max per lamp, 4 lamps per box and 4 boxes
→ max 800W or max 8A total (20A already available on 110V lines)
- ICD updated : position and fixation defined

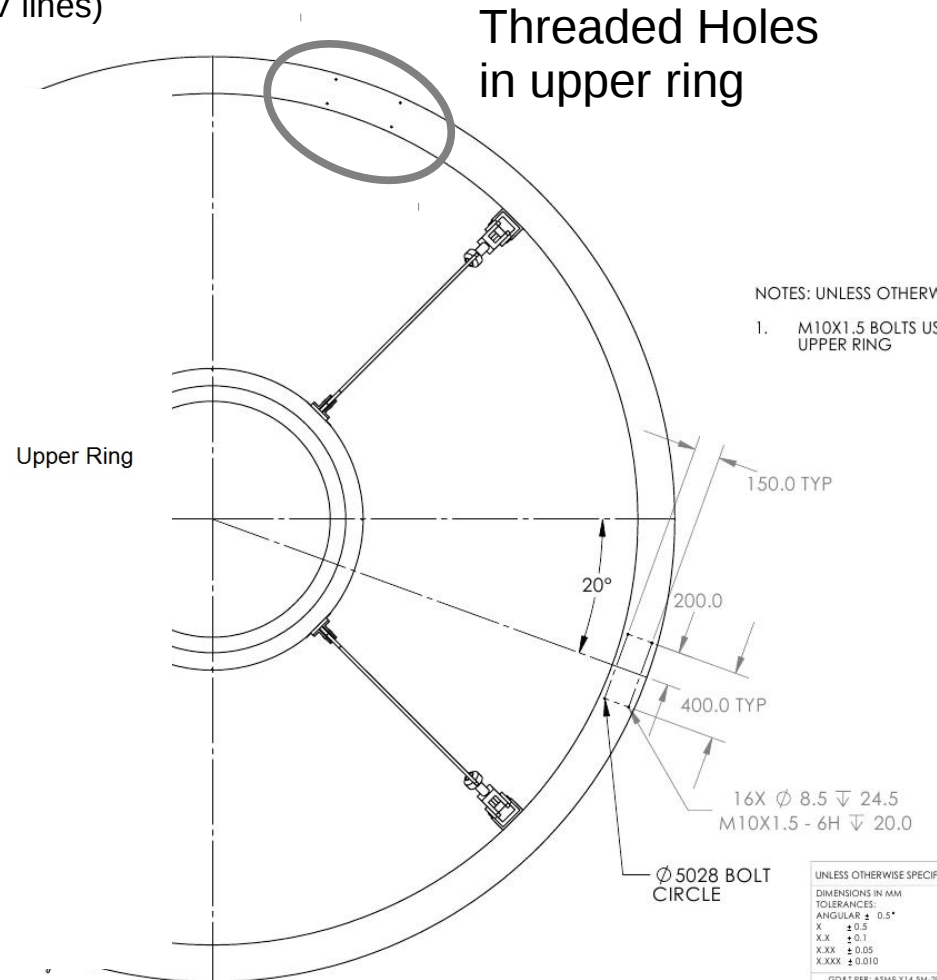
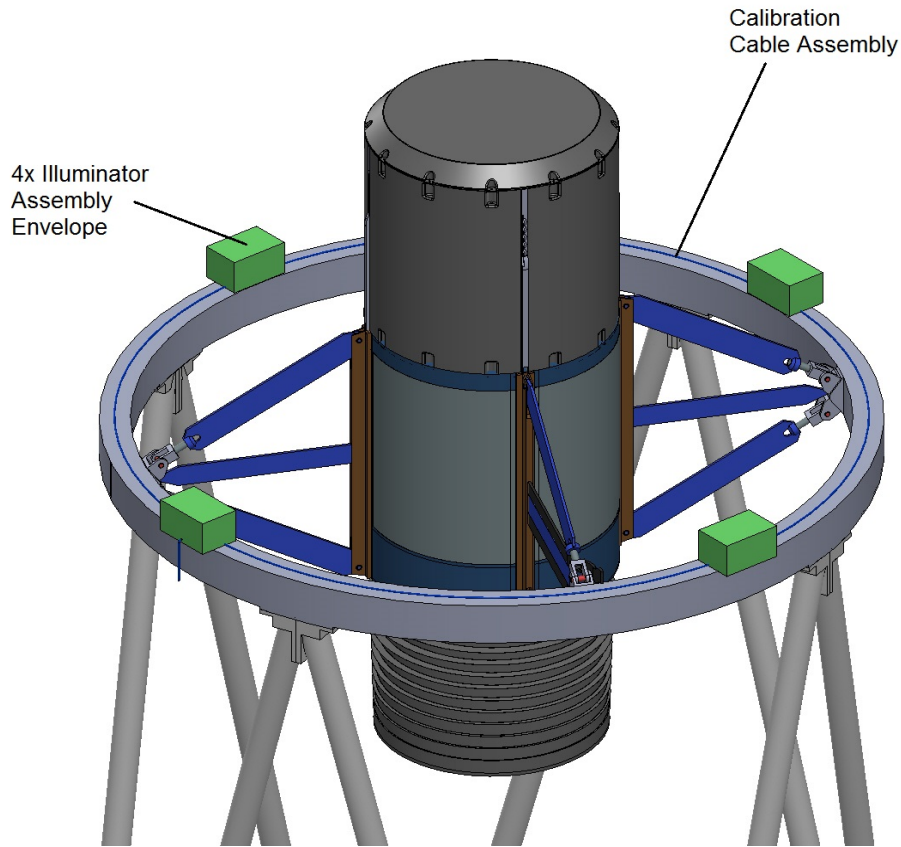

Dark Energy Spectroscopic Instrument

U.S. Department of Energy Office of Science
Lawrence Berkeley National Laboratory

Screen upgrade

- Current screen is too small
- Two upgrade options have been proposed
- Option 2 gives more margin for telescope positioning
- Re-coat existing panels or buy all new ones

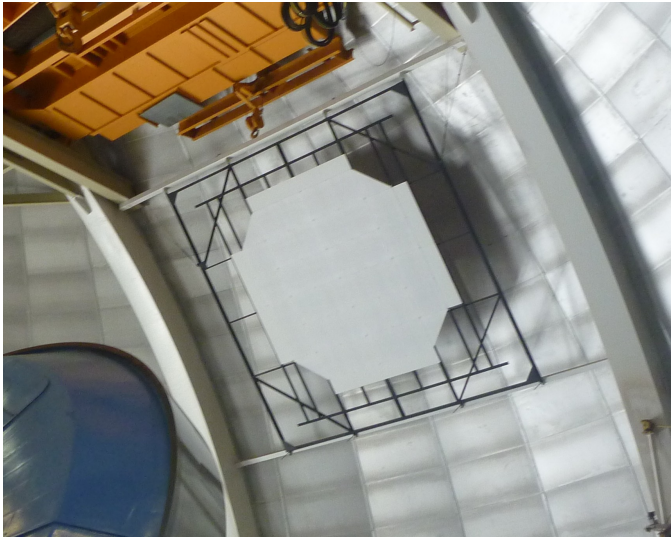

Current screen

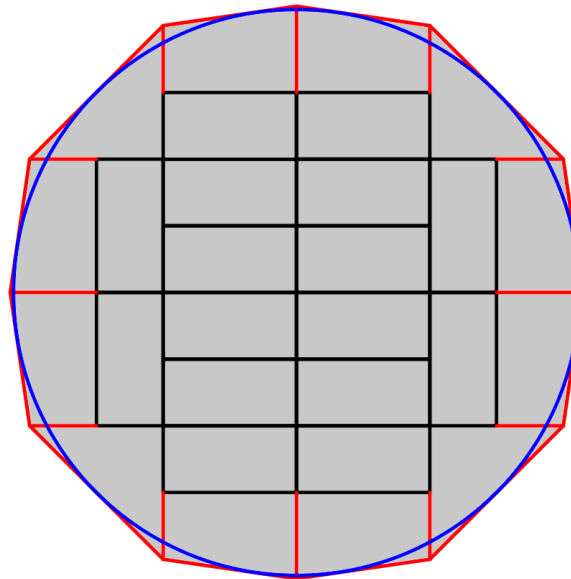

Option 2 upgrade

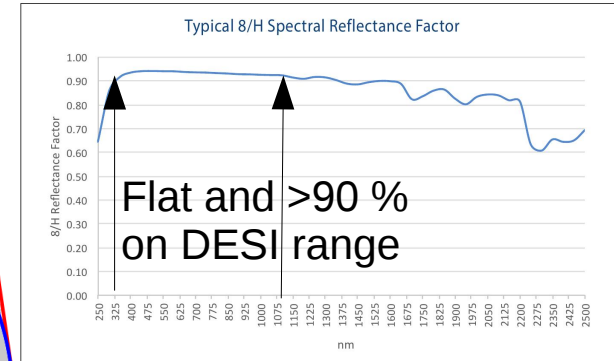

Permafect - 94 BRDF at 20° Incident Beam

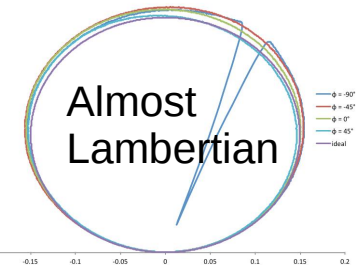

Coating spec



Planning later phase : start 2017 Q4

- Screen :
 - Order panels in time for delivery when DESI dome access (Q4 2017)
 - *NOAO is responsible for*
 - *Installation on frame (dome floor)*
 - *Installation of frame on dome*
- Lamps boxes:
 - Test control hardware/software
 - *NOAO is responsible for :*
 - *Installation on upper ring (dome floor) (Q3 2018)*
 - Test once upper ring is in place
- Full system commissioning
- Calibration data analysis
- Maintenance



Safety items

- Lamps
 - Power → NOAO qualified personnel + integration plan
 - Work in height → NOAO qualified personnel + integration plan
 - Heat
 - System not accessible while in function
 - Investigate temperature monitoring
 - Eyes
 - Tests and integration : protection glasses
 - Calibration shots :
 - Warning “do not enter” sign at dome's doors
 - Protection glasses available
 - Check if visitors gallery window is/need to filter UV
- Screen
 - Work in height → NOAO qualified personnel + integration plan



Test and validation

- Lamps
 - Need to qualify lamps before definitive choice
 - Tests and characterization on the spectrophotometric bench :
 - Spectra with monochromator
repeat measure at different current value for continuum lamp
 - Irradiance
with Si Photodiode calibrated by NIST
readout by Keithley 6514
- Screen
 - No test foreseen before installation
 - Test with full system in place
- Full system to be tested with DESI



Calibration System Milestones

- Mid 2016 : Final lamp choice based on lab tests
- End 2016 : Final Design for illumination system
- Mid 2017 : Order screen parts
- End 2017 : Screen mounted on dome
- Mid 2018 : Illumination system mounted on upper ring
- End 2018 : Test of the full system and Commissioning



Conclusion / perspectives

- Requirements are updated
- Design
 - Mostly done for screen
 - On going for illumination system
- Interfaces
 - Updated ICD with upper ring
 - Need to work on ICD with telescope/instrument control software
- Safety list established
- Planning is defined
- No big hardware development foreseen
- Next item on Calibration System critical path is lamp choice



BackUp slides



Dark Energy Spectroscopic Instrument

U.S. Department of Energy Office of Science
Lawrence Berkeley National Laboratory

Key documents

| Description | Document # |
|---|-------------------------|
| ICS to Calibration System ICD | 559-v0 |
| DESI Calibration System to Upper Ring ICD | 620-v0 |
| Spectral Calibration Tests at the Mayall | 646-v1 |
| DESI Calibration System Requirements | 1067-v0 |
| On site calibration system for DESI spectrographs | 1673 |



Dark Energy Spectroscopic Instrument

U.S. Department of Energy Office of Science
Lawrence Berkeley National Laboratory

Gantt chart full span

- 2 phases:
 - Design and define interfaces : now
 - Build and integrate : late 2017 & 2018

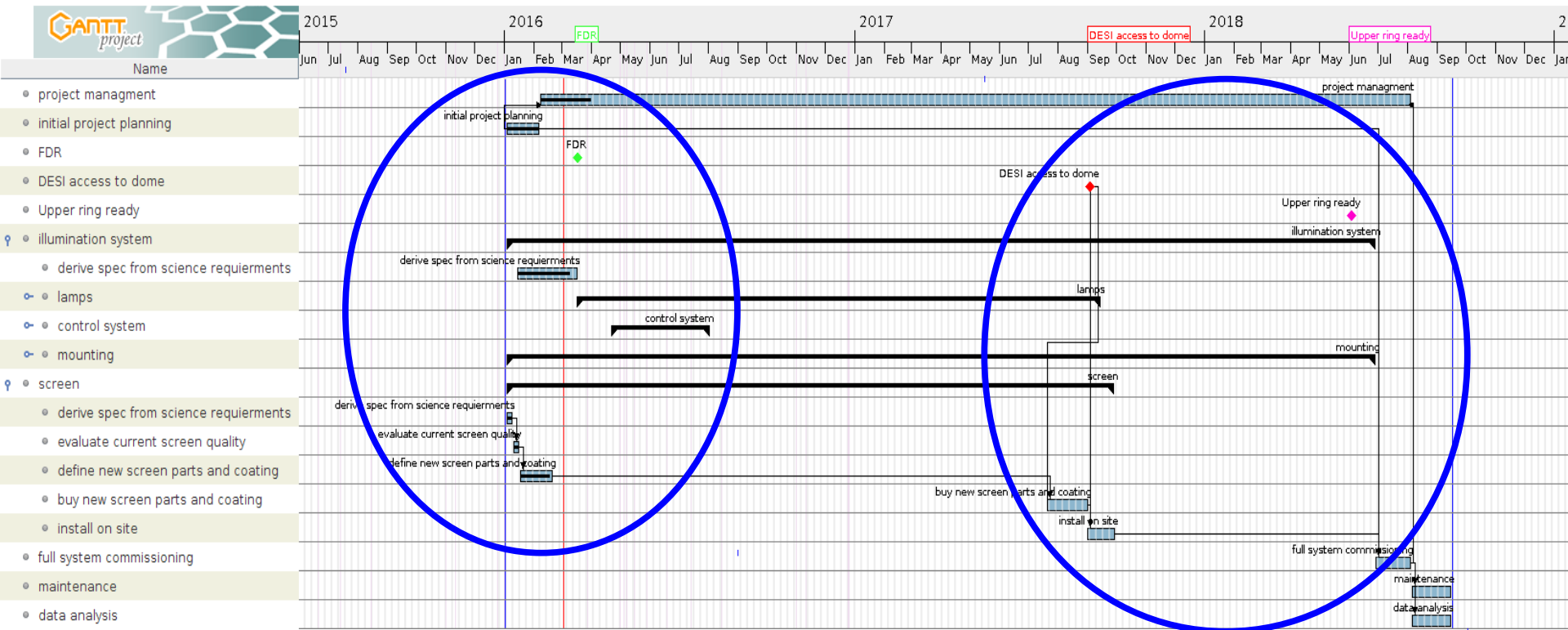

Gantt early phase

- Next big items on critical path : define, buy and test lamps

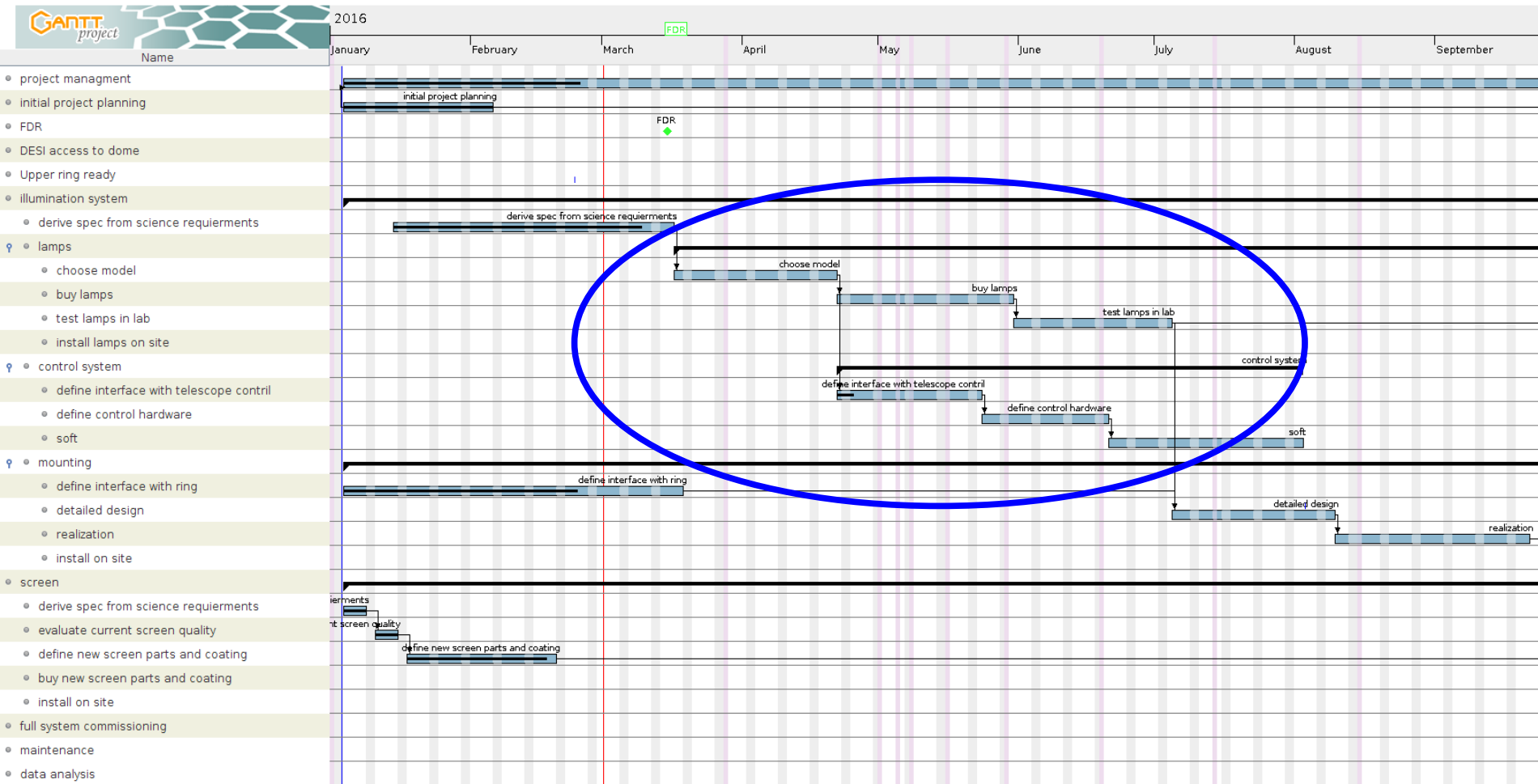

From requirements to specifications:

Spectral coverage

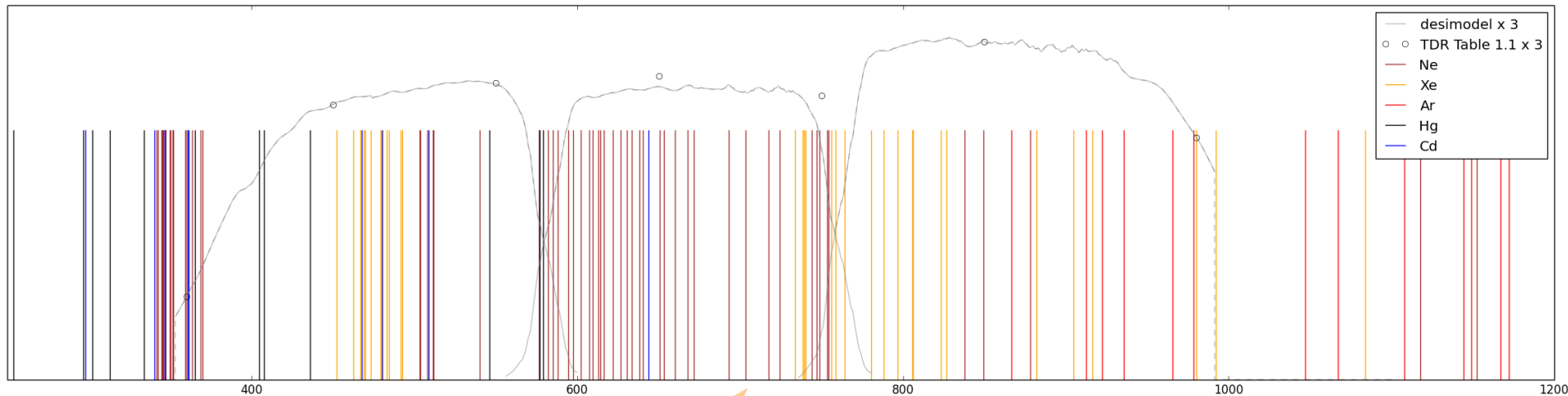

- Gather lamps spectrum data from manufacturer *On going*
- Use new code+DESI model to estimate expected flux and spectrum of lamps *On going*

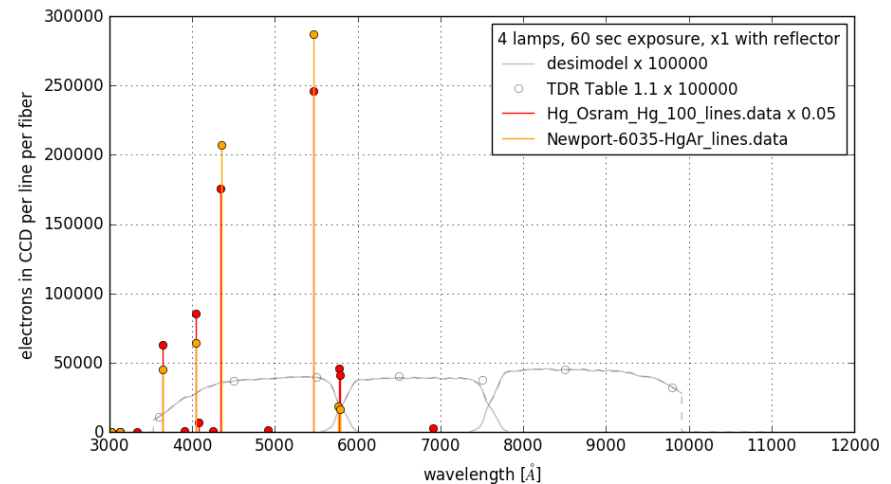

Brighter Fatter

- In deep-depleted CCDs : shrinking of the CCD pixels with the accumulation of charges
- This could give an apparent broadening of emission lines with intensity
- For instance: broadening of the PSF of 1% for a charge of 60,000 electrons for the brightest pixel in the spot

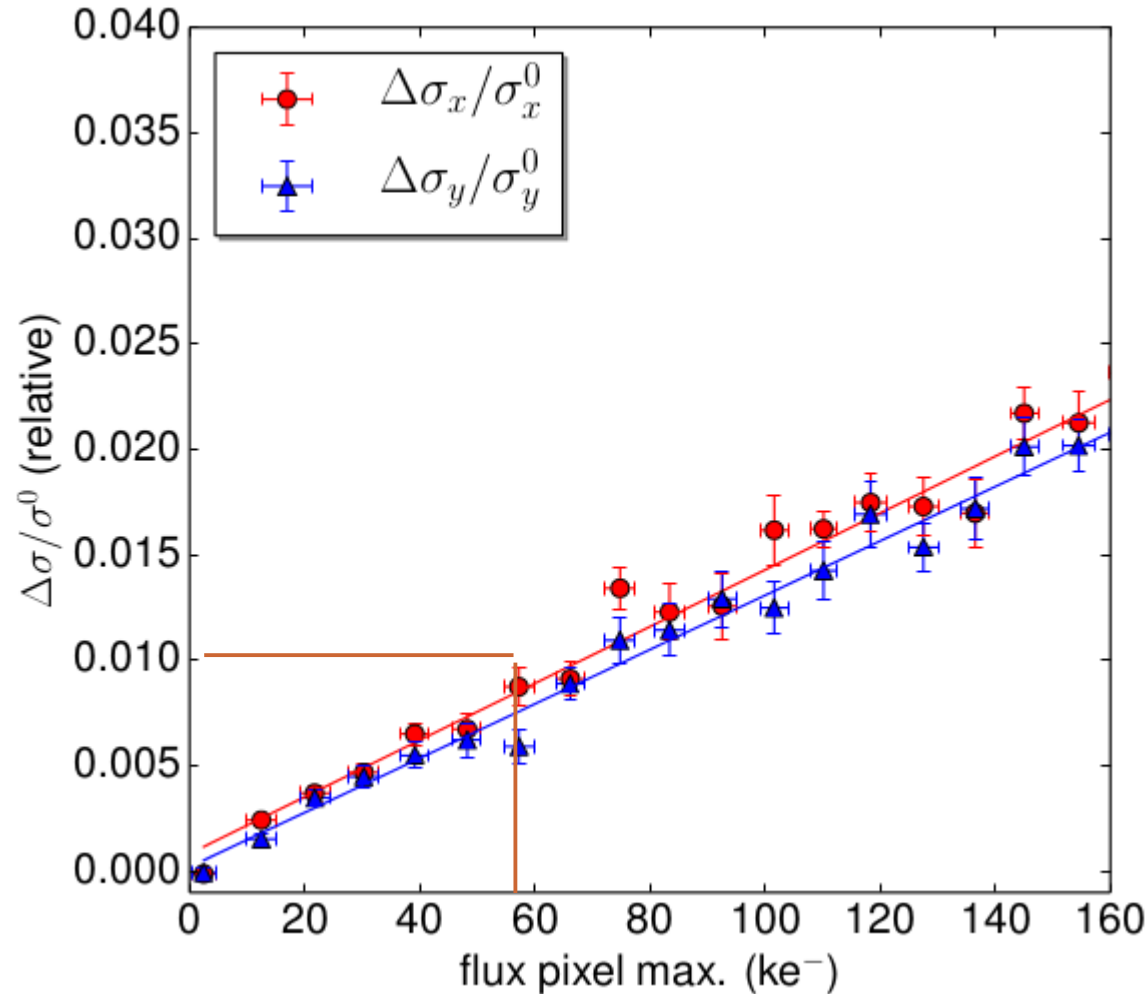

Dark Energy Spectroscopic Instrument

U.S. Department of Energy Office of Science
Lawrence Berkeley National Laboratory

Error on tracks : X

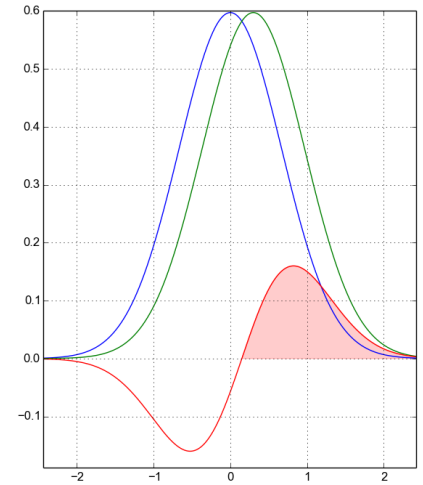
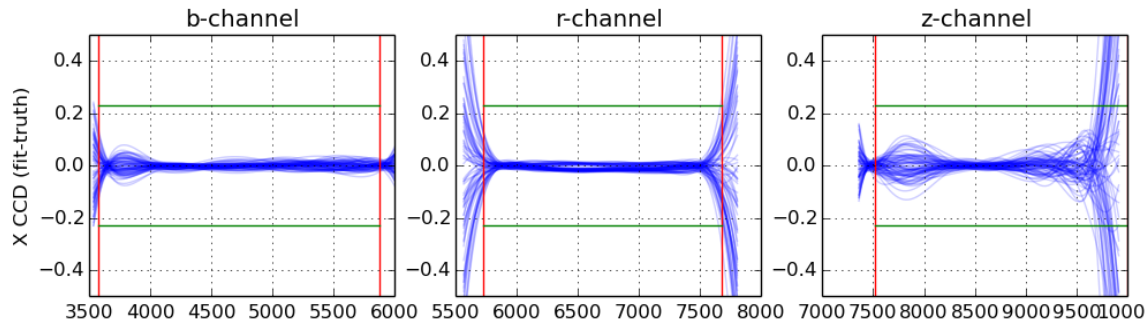

- An offset in the fitted trace position of one fiber will result in an underestimated flux.
- Assuming again a Gaussian cross-dispersion profile, the relative bias on flux is $\epsilon = -(\Delta x / (2\sigma_x))^2$.
- Requiring a spectro-photometric error smaller than $|\epsilon| = 0.01$ gives $\Delta x < 0.2\sigma_x = 0.085 \times \text{FWHM}$.
- The minimal cross-dispersion FWHM are of 2.74, 2.76 and 2.86 pixels for the b, r, and z channels (desimodel v0.4).
- This translates into a requirement for the trace location precision of 0.23, 0.23 and 0.24 pixels.
- We will retain a requirement of $\Delta X < 0.23$ pixel in the following



Dark Energy Spectroscopic Instrument

U.S. Department of Energy Office of Science
Lawrence Berkeley National Laboratory

Error on tracks : Y

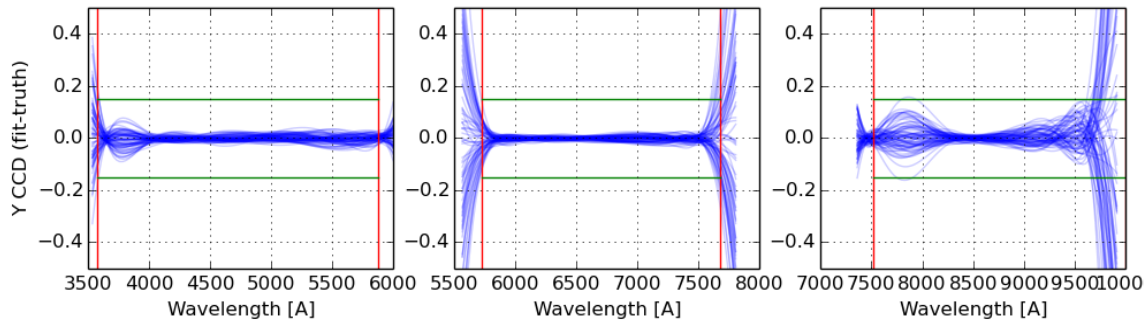

- Sky background subtraction requires a precise relative wavelength calibration among fibers.
- A wavelength calibration error $\Delta\lambda$ in one fiber relative to the others will give sky line residuals with a typical profile composed of a negative bump followed by positive one
- The DESI spectral (1D) PSF can be approximated with a Gaussian profile of parameter $\sigma_\lambda = \text{FWHM}/2.35$, the integral of the positive bump is a fraction $\Delta\lambda / (2\pi\sigma_\lambda)$ of the sky line intensity (the approximation is valid for $\Delta\lambda \ll \sigma_\lambda$).
- We can now use the requirement that the sky residuals do not exceed a fraction = 0.05 of total sky signal to obtain a requirement on the wavelength calibration $\Delta\lambda < 0.05 \sqrt{2\pi}\sigma_\lambda = 0.125 \times \sigma_\lambda = 0.053 \times \text{FWHM}$.
- The DESI spectral (1D) PSF FWHM minimal values are 1.70, 1.57 and 1.84 A in the b, r, and z channels respectively
- wavelength calibration precision are of 0.09, 0.083 and 0.097 A
- corresponding to 0.152, 0.156, and 0.161 CCD pixels along the dispersion axis (CCD columns)
- We will retain a requirement of $\Delta Y < 0.15$ pixel



Title template

- Information template

