

DESI SM#5 & SM#6 Throughput Measurement

Laurent Le Guillou
(Sorbonne Univ. / LPNHE)
Julien Guy
(LBL)

DESI Spectro Telecon
2019-06-04

LPNHE : Julien Coridian, Patrick Ghislain, Julien Guy, Sonia Karkar, Laurent Le Guillou,
Yann Orain, Philippe Repain, Eduardo Sepulveda
AMU : Pierre-Eric Blanc, Sandrine Perruchot, Xavier Regal, Samuel Ronayette
CEA : C. Magneville



Meas. campaign: SM#4 (feb. '19)

- **SM#5 campaign: Avril 2nd-4st (LLG, PEB)**
- **SM#6 campaign: May 15th-17st (LLG, PEB)**
 - Everything went well
 - Some extra scans (full 10x10mm photodiode scans) for FRD



Exposure time : shutter time correction

- Series of exposures with **increasing exposure time** and **different neutral densities** filters have been taken and analysed.
- Assuming at least linearity for low fluxes, we were able to estimate an effective exposure time correction (**same result on the 3 arms**) :

$$\Delta t_{\text{effective}}^{\text{EM}\#1} = [\text{EXPREQ}] + 0.36 \text{ s} \pm 0.01 \text{ s}$$

$$\Delta t_{\text{effective}}^{\text{SM}\#1} = [\text{EXPREQ}] + 0.662 \text{ s} \pm 0.003 \text{ s}$$

$$\Delta t_{\text{effective}}^{\text{SM}\#2} = [\text{EXPREQ}] + 0.660 \text{ s} \pm 0.004 \text{ s}$$

$$\Delta t_{\text{effective}}^{\text{SM}\#3} = [\text{EXPREQ}] + 0.637 \text{ s} + 0.004 \text{ s}$$

$$\Delta t_{\text{effective}}^{\text{SM}\#4} = [\text{EXPREQ}] + 0.660 \text{ s} \pm 0.005 \text{ s}$$

$$\Delta t_{\text{effective}}^{\text{SM}\#5} = [\text{EXPREQ}] + 0.658 \text{ s} \pm 0.004 \text{ s}$$

$$\Delta t_{\text{effective}}^{\text{SM}\#6} = [\text{EXPREQ}] + 0.681 \text{ s} + 0.017 \text{ s}$$



SM#5: Gains measured at CEA/Saclay (CMV)

- Much better CCDs than EM#1, readout system with identical setup at CEA & Winlight
- Gains obtained with a PTC with **true flats on the CEA / Saclay testbench** after CCD integration into the cryostats (Ch. Magneville (CMV) & colleagues).

Amplifier <i>(Blue CCD)</i>	gain
B1-A <i>(CEA top-left)</i>	1.30
B1-B <i>(CEA bottom-left)</i>	1.29
B1-C <i>(CEA top-right)</i>	1.29
B1-D <i>(CEA bottom-right)</i>	1.29

Amplifier <i>(Red CCD)</i>	gain
R1-A <i>(CEA top-right)</i>	1.68
R1-B <i>(CEA top-left)</i>	1.48
R1-C <i>(CEA bottom-right)</i>	1.60
R1-D <i>(CEA bottom-left)</i>	1.53

Amplifier <i>(NIR/Z CCD)</i>	gain
Z1-A <i>(CEA bottom-right)</i>	1.44
Z1-B <i>(CEA bottom-left)</i>	1.47
Z1-C <i>(CEA top-right)</i>	1.61
Z1-D <i>(CEA top-left)</i>	1.53



SM#6: Gains measured at CEA/Saclay (CMV)

- Much better CCDs than EM#1, readout system with identical setup at CEA & Winlight
- Gains obtained with a PTC with **true flats on the CEA / Saclay testbench** after CCD integration into the cryostats (Ch. Magneville (CMV) & colleagues).

Amplifier <i>(Blue CCD)</i>	gain
B1-A <i>(CEA top-left)</i>	1.30
B1-B <i>(CEA bottom-left)</i>	1.29
B1-C <i>(CEA top-right)</i>	1.305
B1-D <i>(CEA bottom-right)</i>	1.32

Amplifier <i>(Red CCD)</i>	gain
R1-A <i>(CEA top-right)</i>	1.93
R1-B <i>(CEA top-left)</i>	1.85
R1-C <i>(CEA bottom-right)</i>	1.70
R1-D <i>(CEA bottom-left)</i>	1.71

Amplifier <i>(NIR/Z CCD)</i>	gain
Z1-A <i>(CEA bottom-right)</i>	1.45
Z1-B <i>(CEA bottom-left)</i>	1.49
Z1-C <i>(CEA top-right)</i>	1.70
Z1-D <i>(CEA top-left)</i>	1.68



Direct throughput estimate (without a model)

- We first estimate the spectrograph throughput by **dividing the integrated flux in each CCD** (for each LED and each fiber 11-20) by the **injected flux (DKD)** :

$$\eta_{[e^-/\gamma]}(\lambda_{\text{LED}}) = (QE_{\text{CCD}} \times T_{\text{optics}}(\lambda_{\text{LED}})) = \frac{\phi_{[e^-/s]}^{\text{CCD}}(\text{LED})}{\phi_{[\gamma/s]}^{\text{injected}}(\text{LED})}$$

- A this step, no FRD correction.
- What we got that way is an **estimate of the spectrograph throughput** at the LED wavelength (weighted by the LED spectrum)
- Comparison with the **DESI generic optical model (without fibers)**



SM#5 : direct throughput estimate

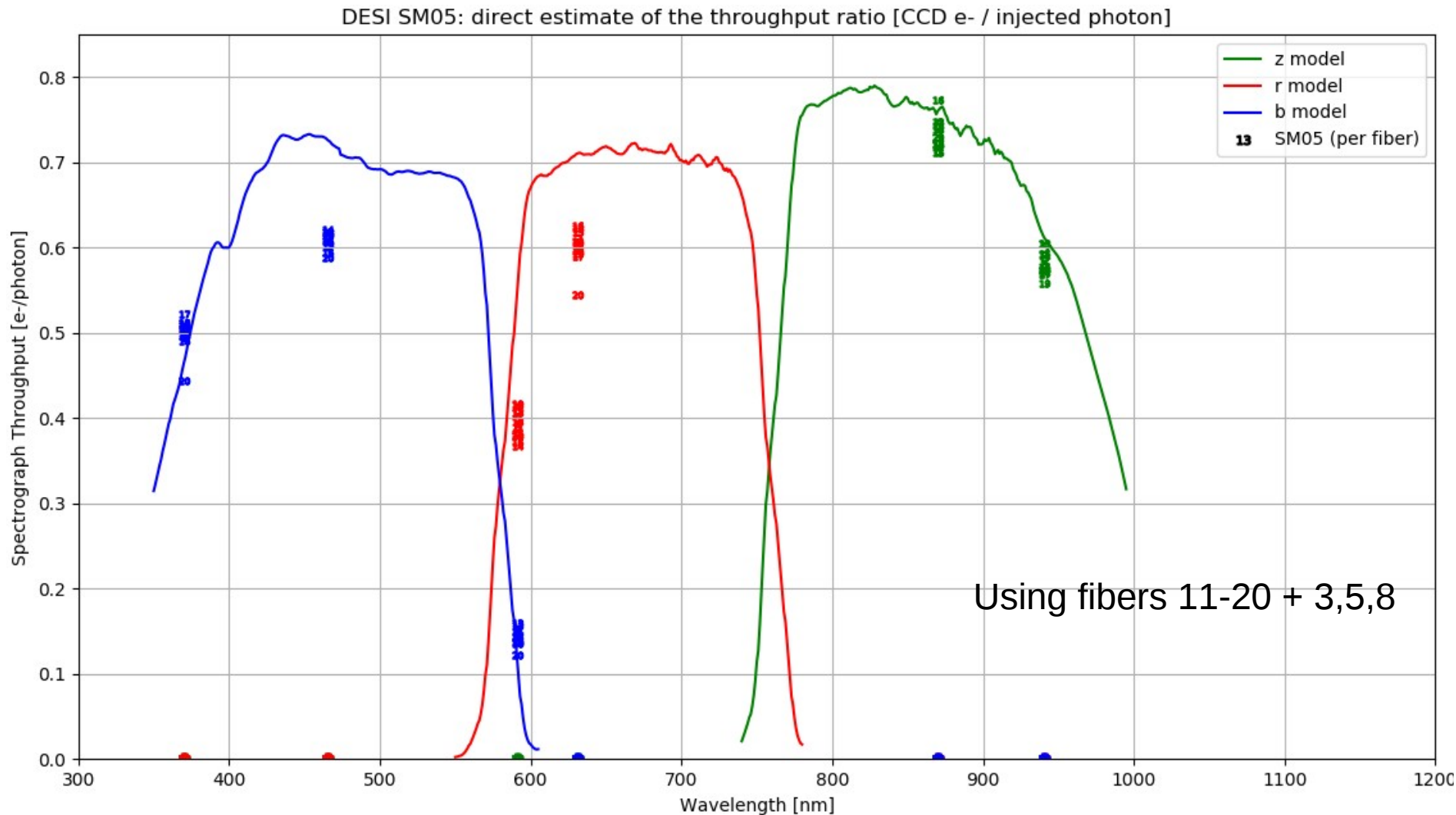

SM#5 : direct throughput estimate (no FRD corr.)

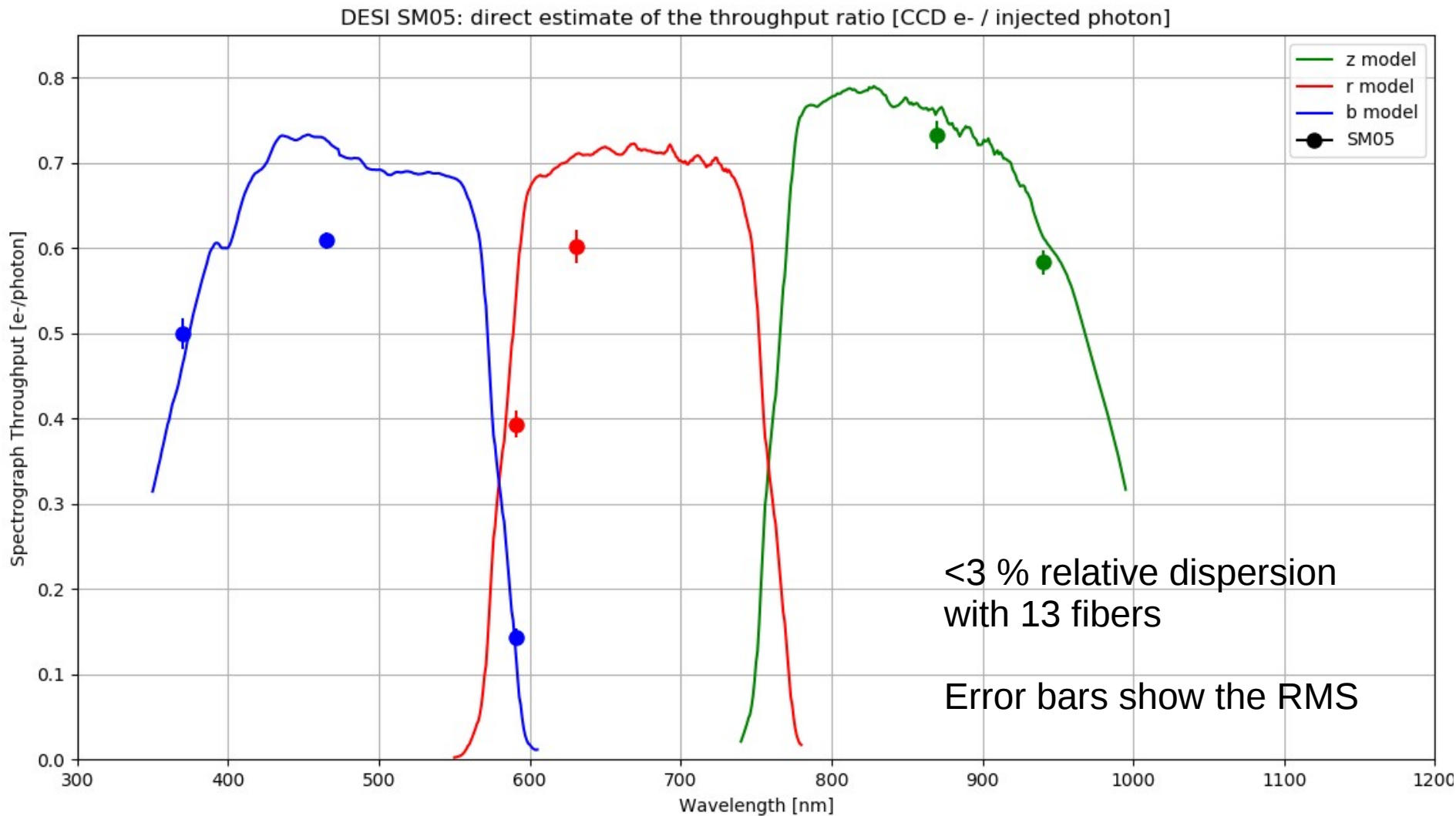

SM#6 : direct throughput estimate

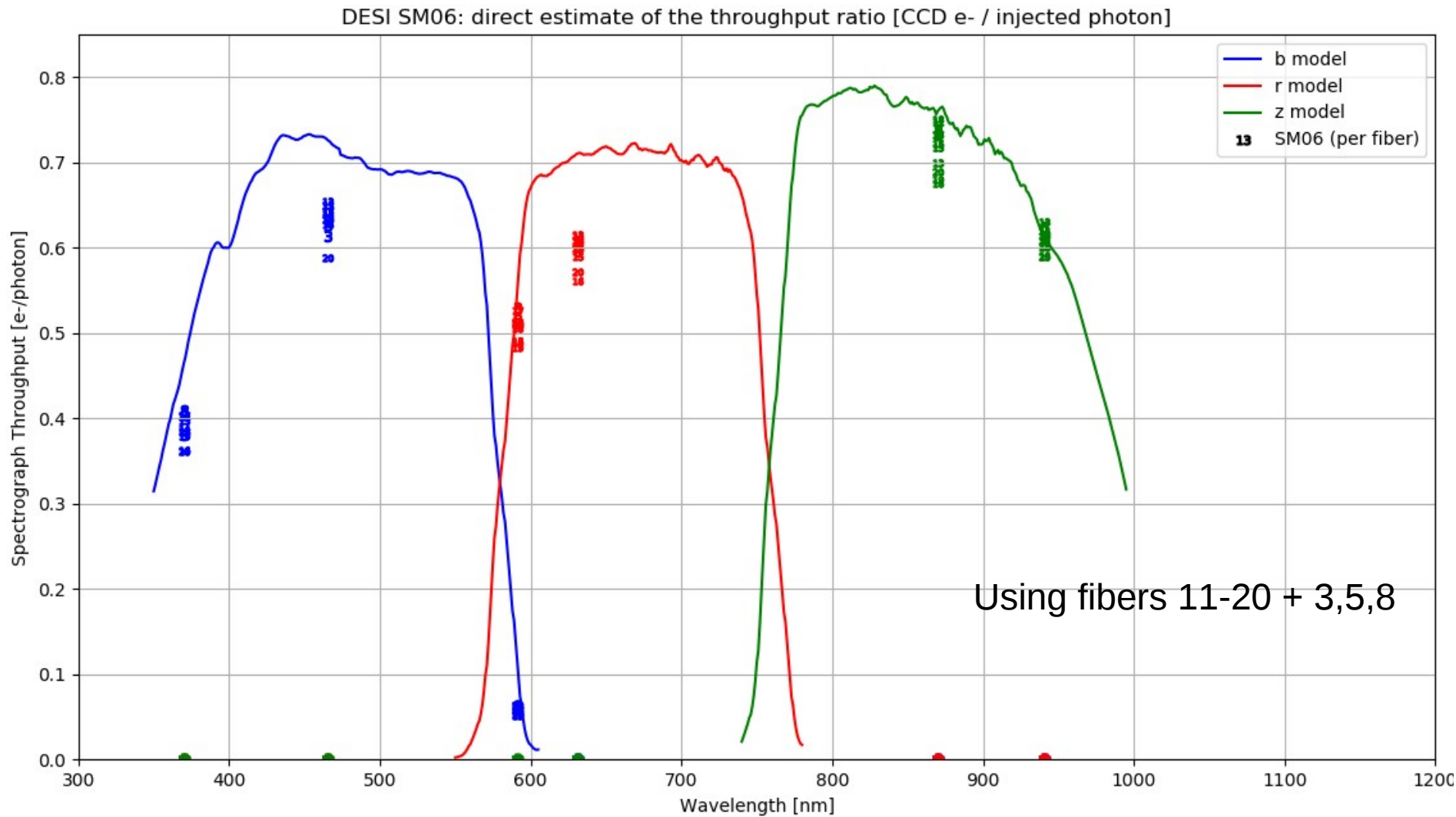

SM#6 : direct throughput estimate (no FRD corr.)

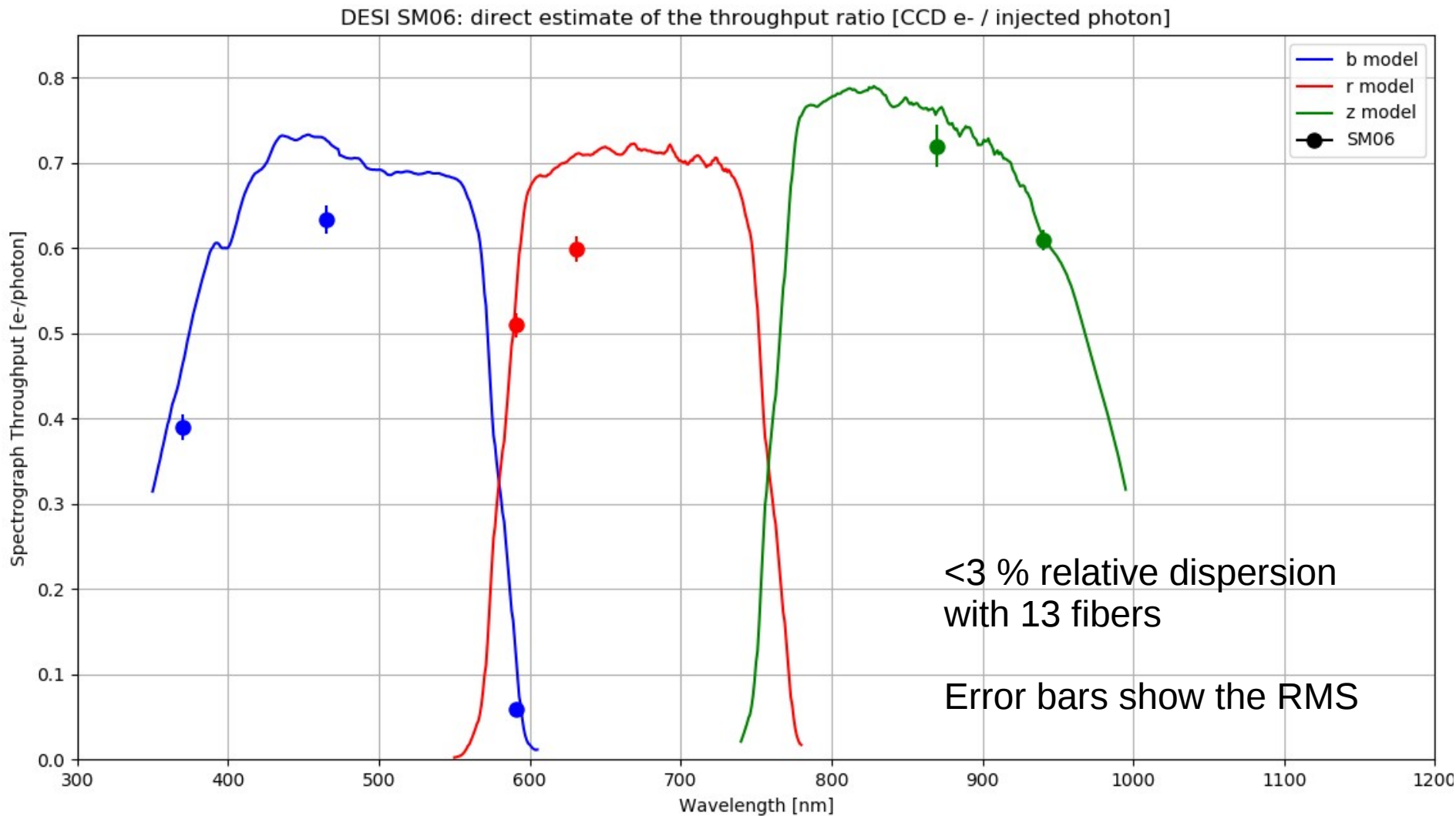

Suppl. Slides



The DESI spectrograph

- 10 identical spectrographs
- 10 x 500 fibers
- 3 arms :
NIR, Red, Blue
- **Fiber slit (500 fibers)**
may be removed and replaced by a sparse fiber slit for tests.

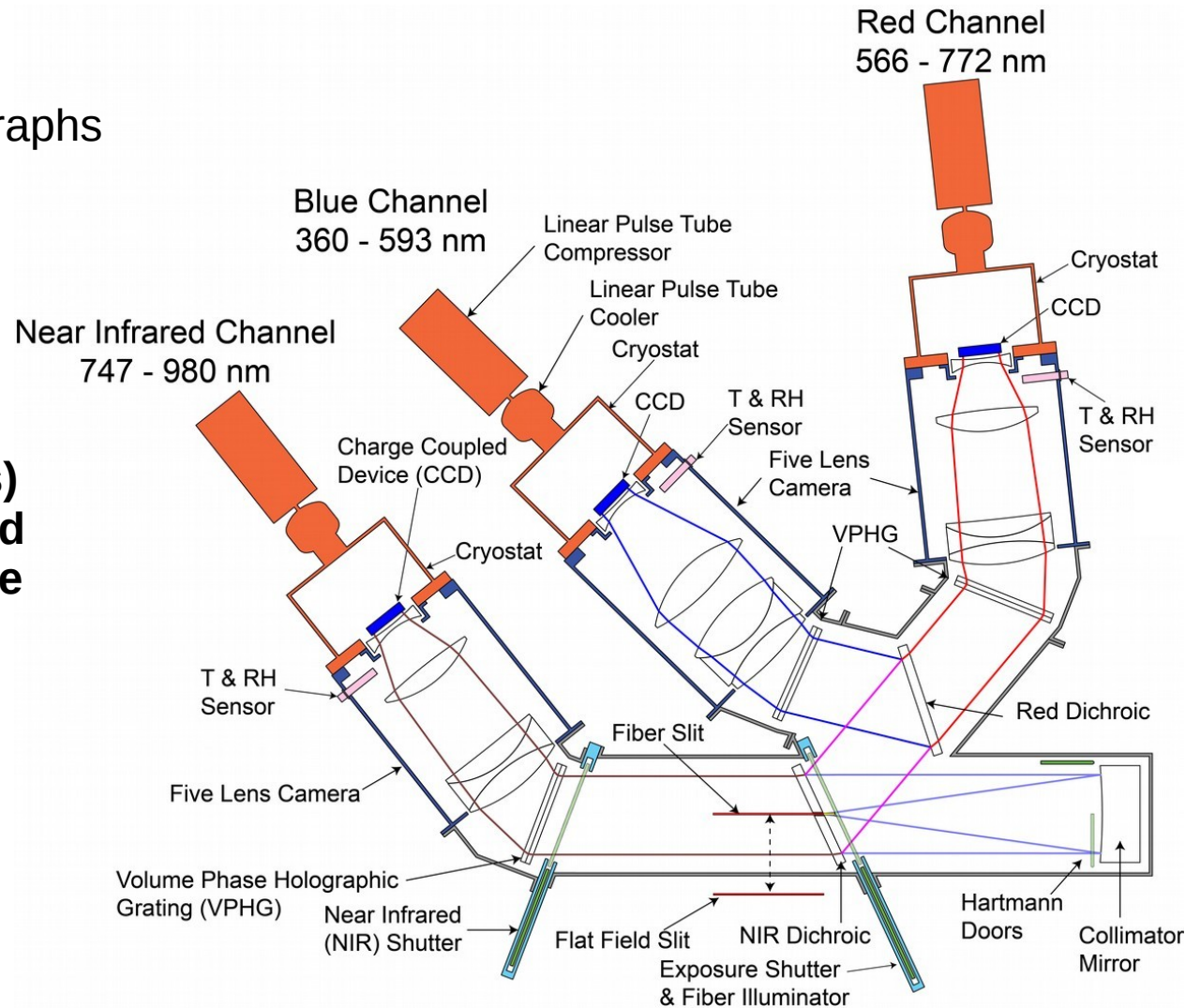

The DESI spectrograph

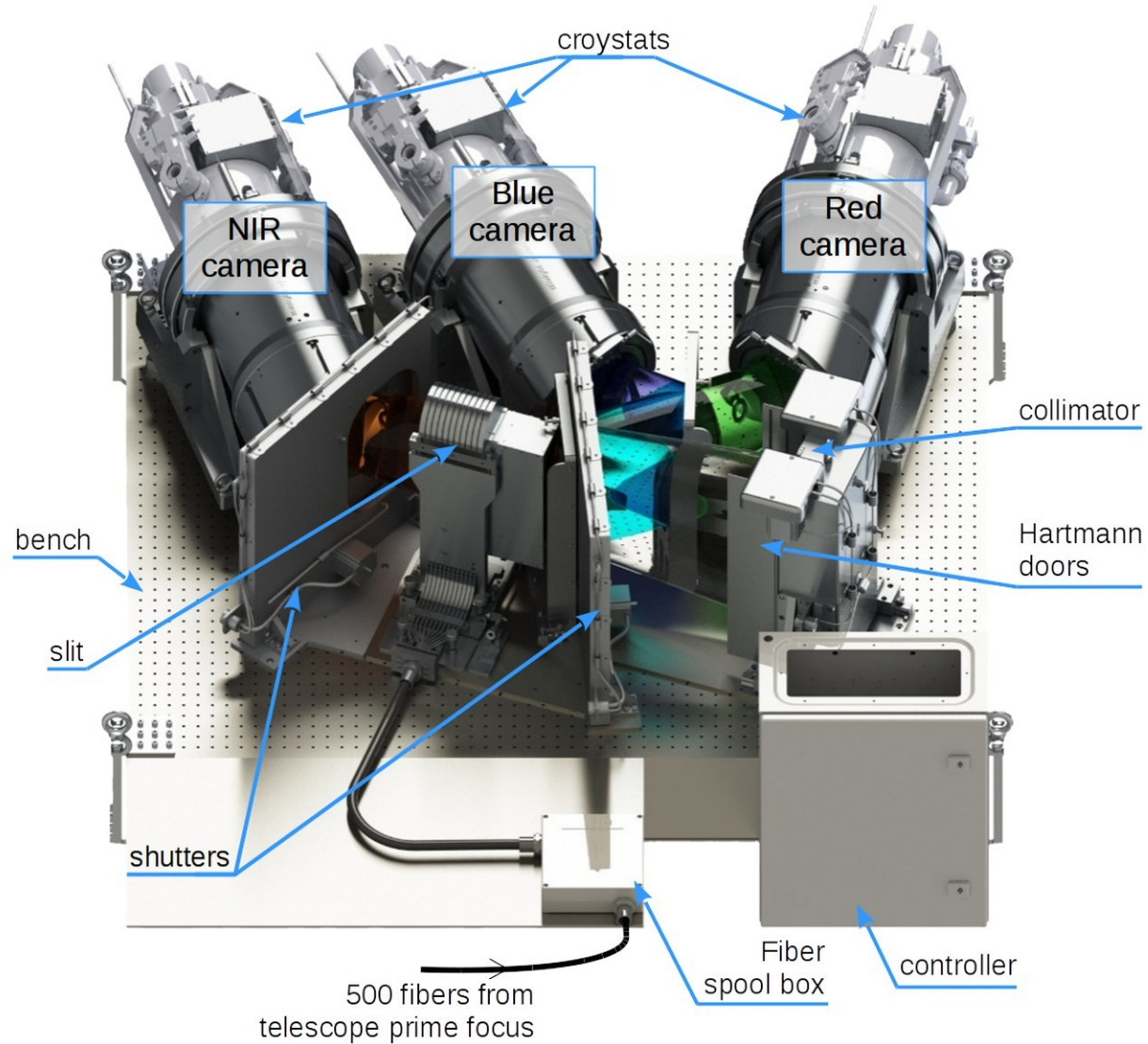

Throughput measurement device

Motorized
linear stage
Pi/MICOS
<0.4 μm accuracy

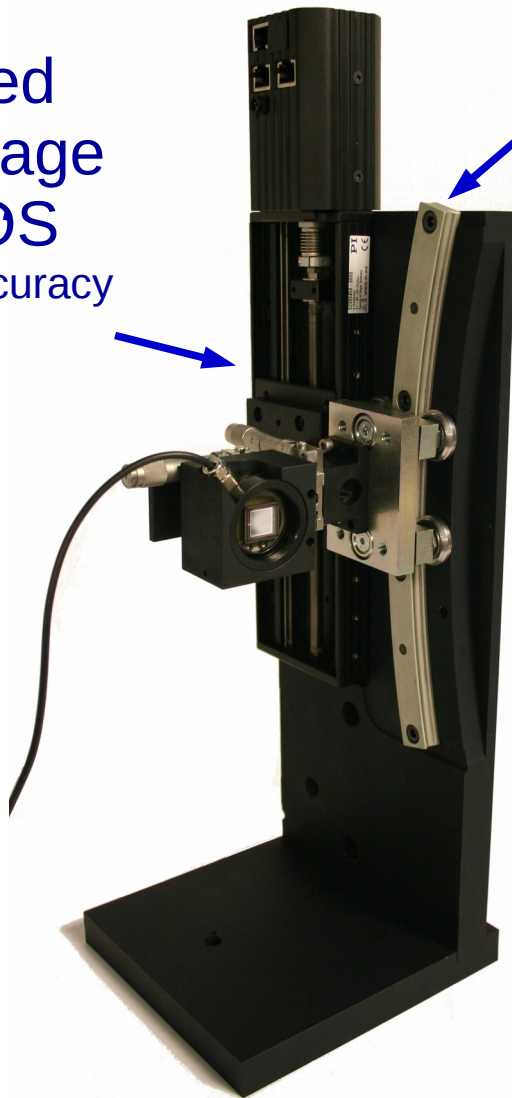

Curved rail
(radius 500 mm)

Calibrated
Photodiode
10x10 mm²

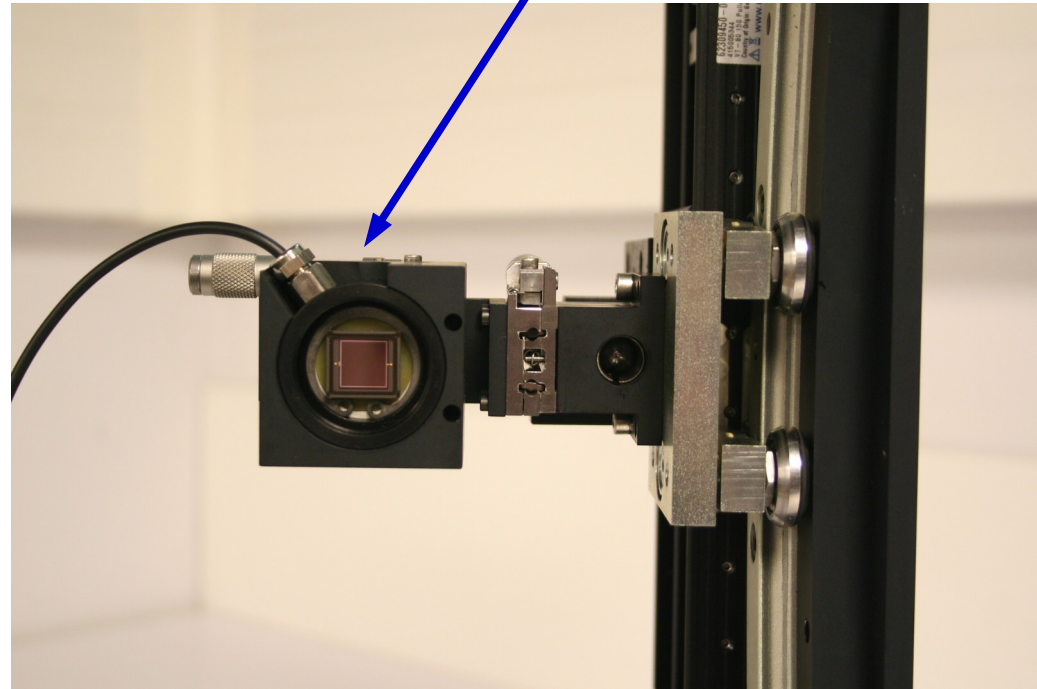

Mechanical design

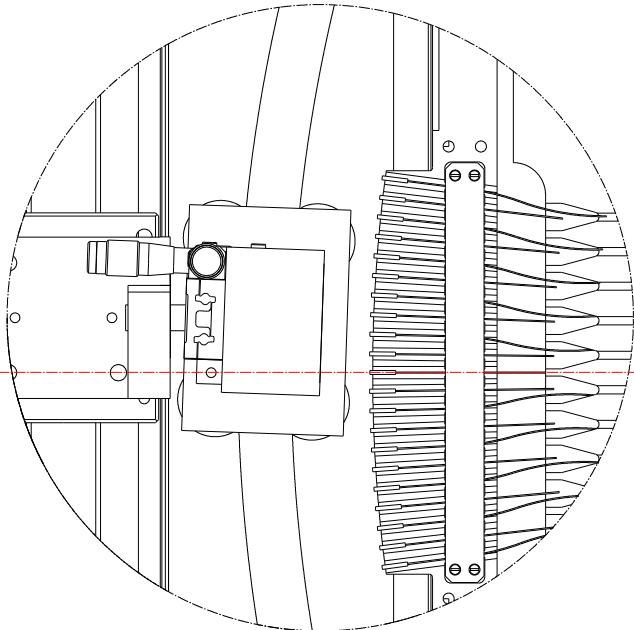

Détail A
Echelle : 2:1

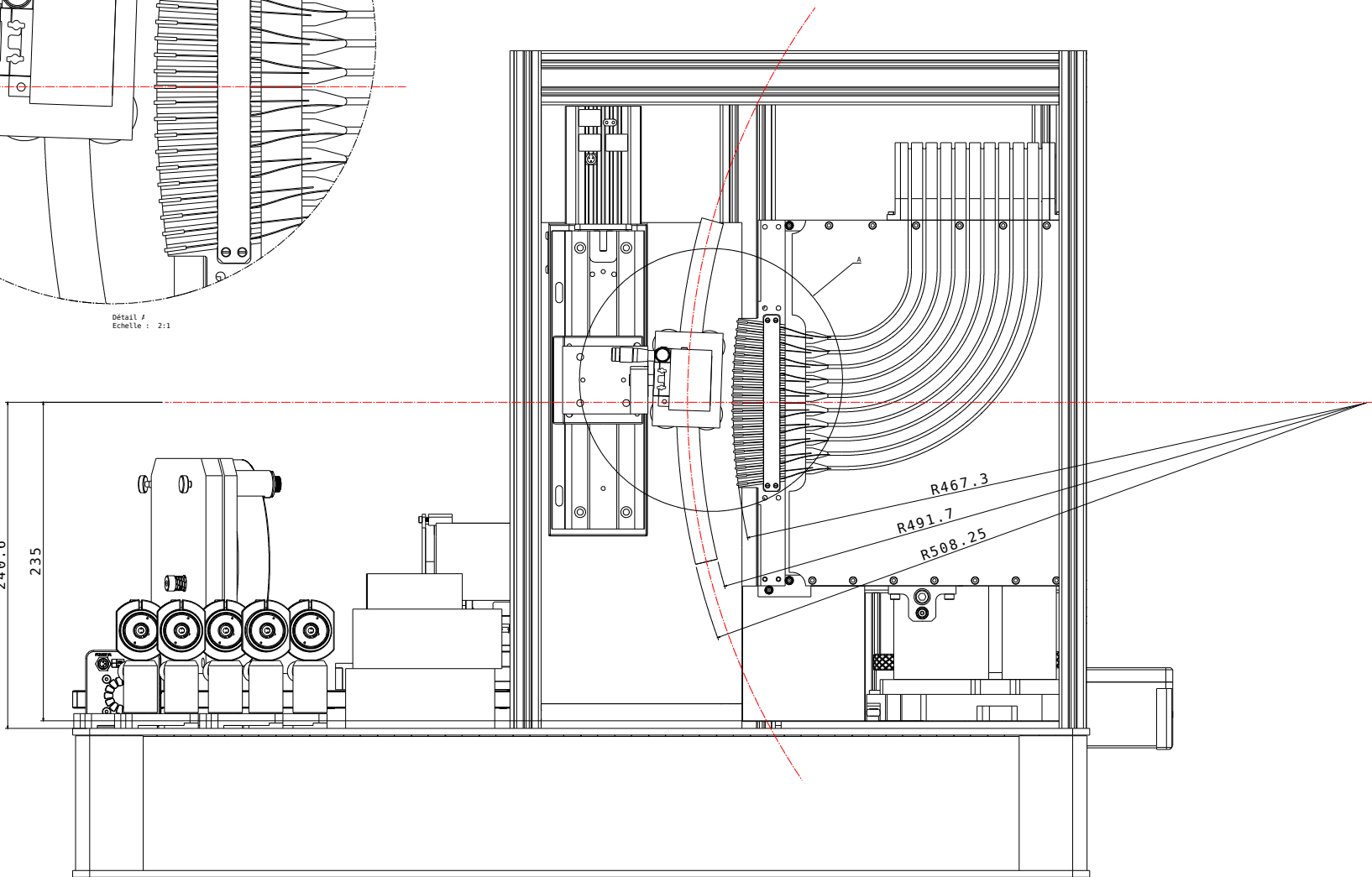

240.6

235

R467.3

R491.7

R508.25

A

Throughput measurement device

Dedicated
Dark Box

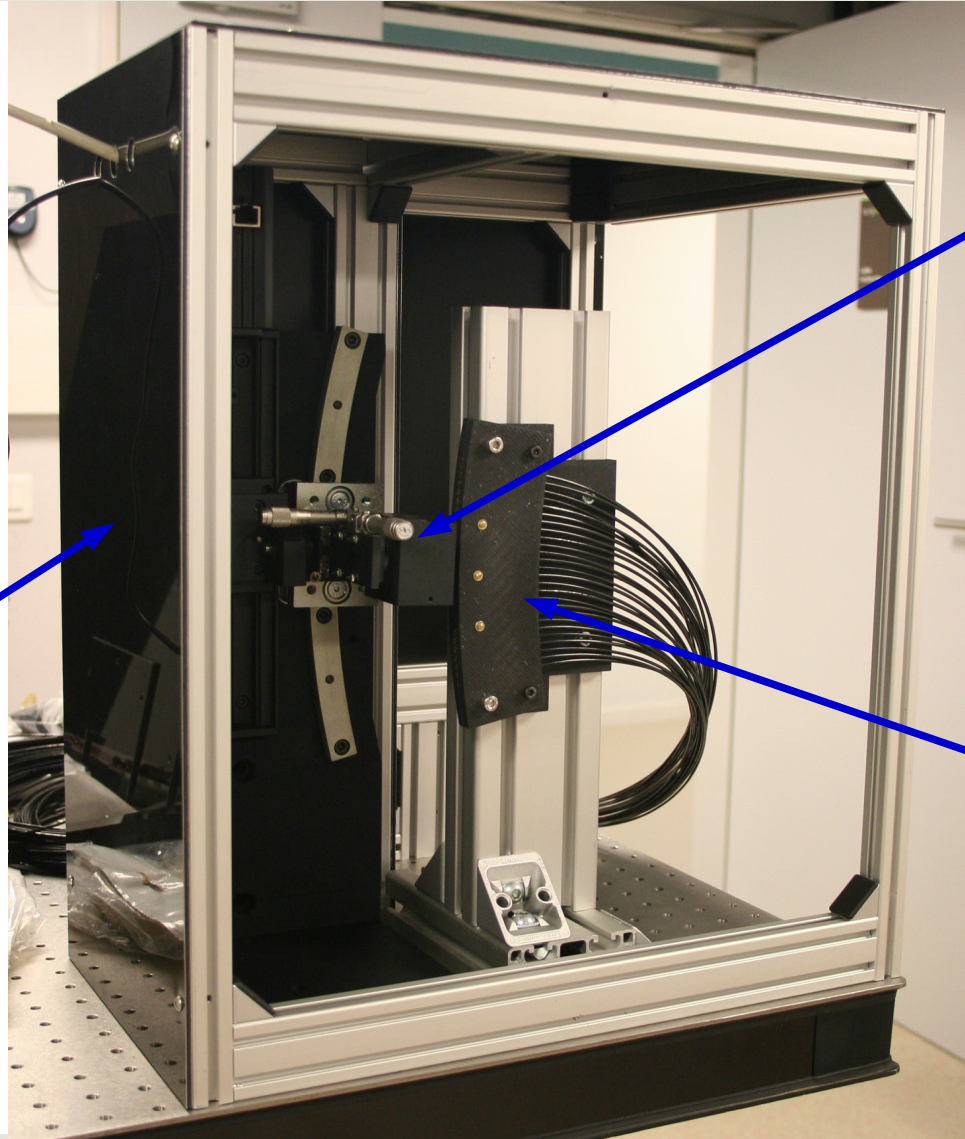

Calibrated
Photodiode

Mock test slit
3D printed
Old fiber bundle
(DESY, H1)



Illumination Testbench

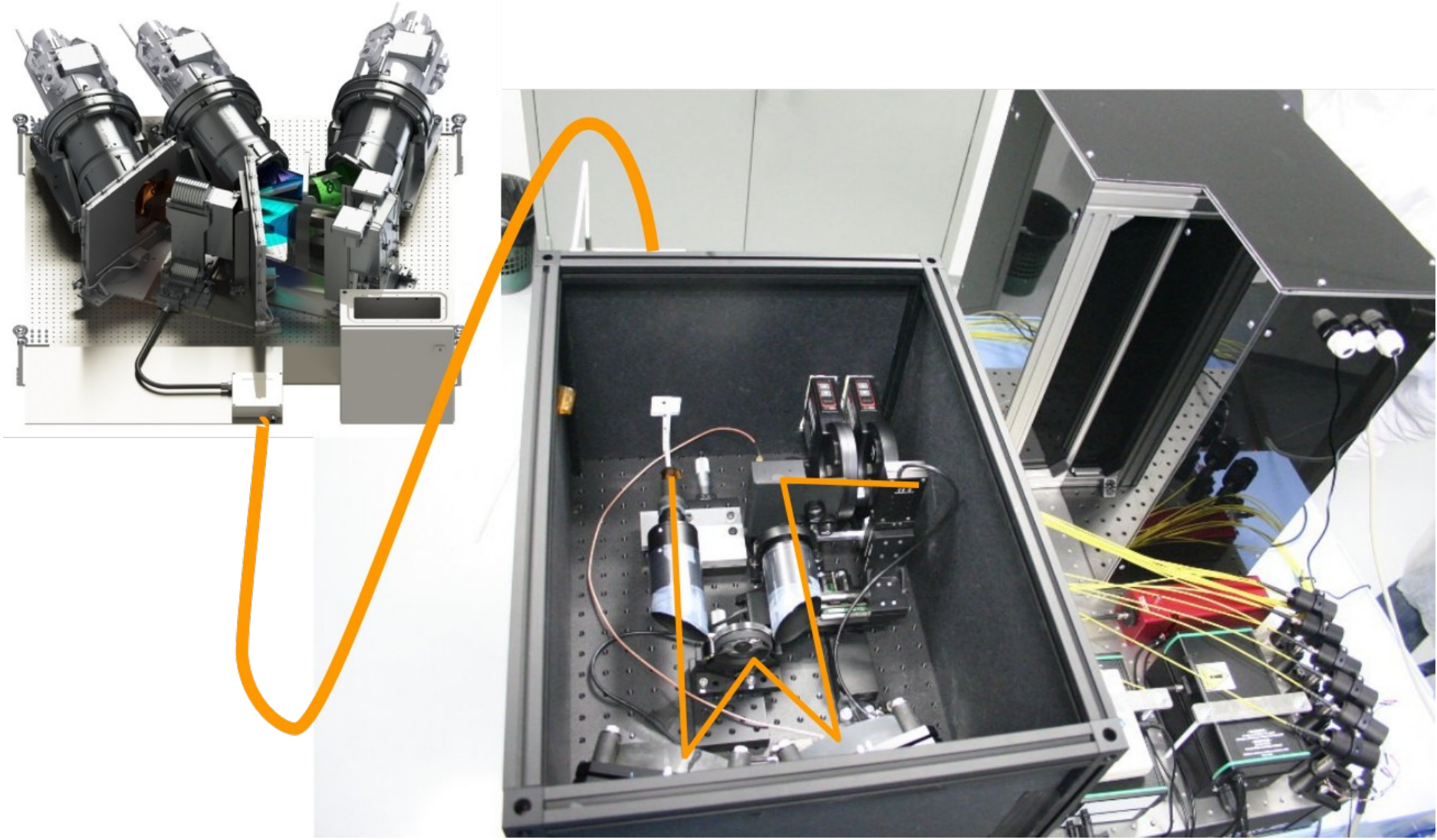

Dark Energy Spectroscopic Instrument

Laurent Le Guillou (Sorbonne Université / LPNHE), Julien Guy (LBL)
DESI Spectro Telecon – 2018-12-18

Installation of our device at Winlight

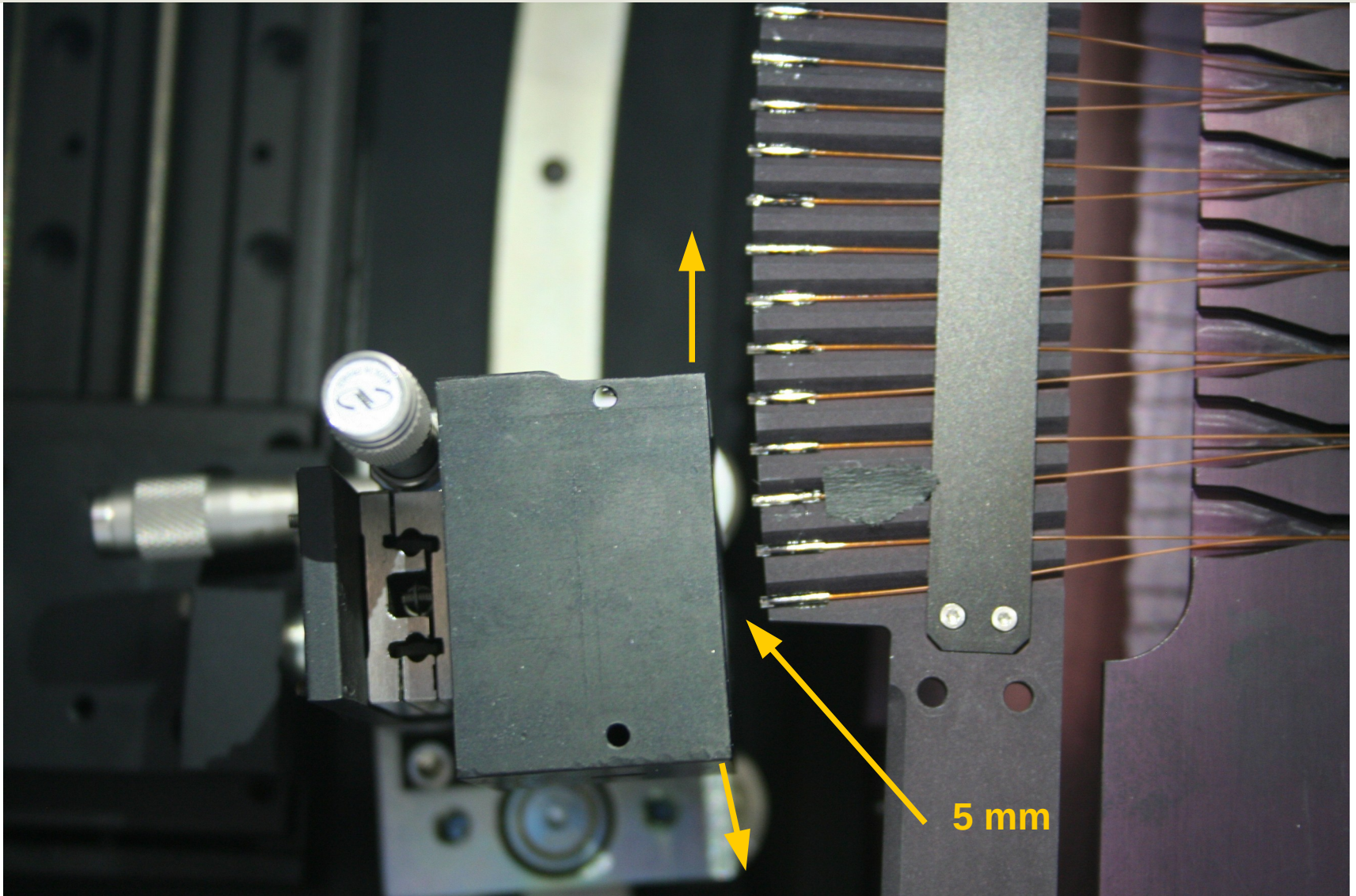

Dark Energy Spectroscopic Instrument

Laurent Le Guillou (Sorbonne Université / LPNHE), Julien Guy (LBL)
DESI Spectro Telecon – 2018-12-18

DKD photocurrents analysis

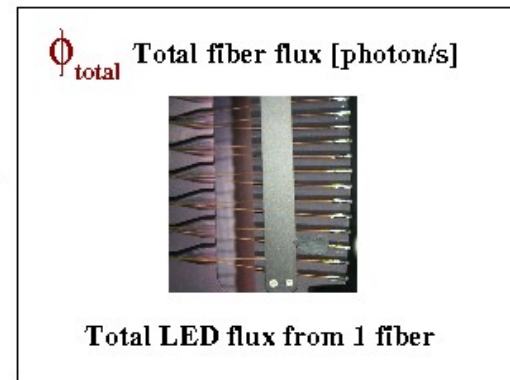
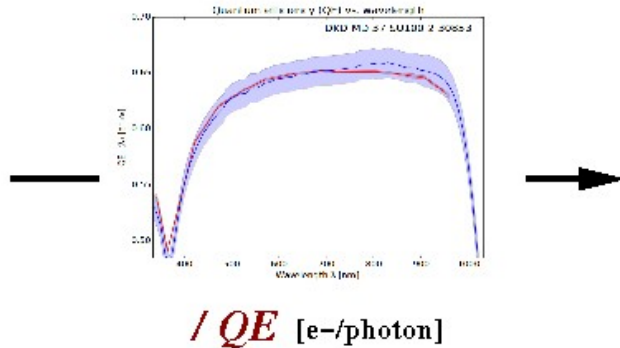
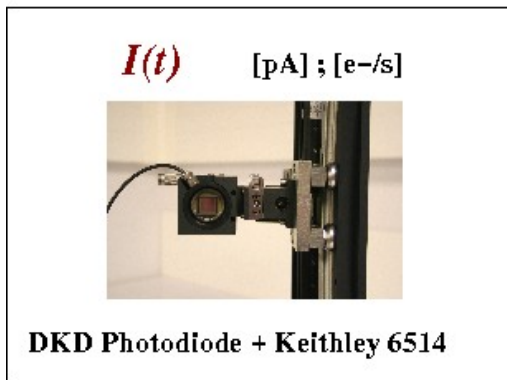

FRD correction

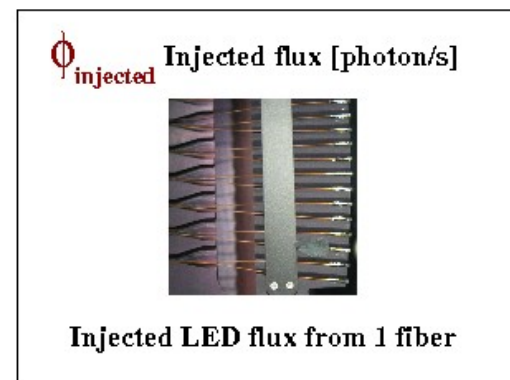

$$\Phi_{injected} = \frac{I - I_{dark}}{QE_{DKD, LED}} \times FRD_{fiber}$$

$$QE_{DKD, LED} = \frac{\int \phi_{LED}(\lambda) QE_{DKD}(\lambda) d\lambda}{\int \phi_{LED}(\lambda) d\lambda}$$



Throughput measurement principles

- Measurement to be done during **slit removal/reinstall** repeatability test (limited overhead)
- **Calibration of the total flux** at the exit of each fiber of the sparse fiber slit
- **Proposed Procedure** : for the same illumination setups (LEDs)
 - **(1) Sparse Test Slit outside of the spectrograph, in front of our device** : flux (in the same illumination conditions) measured by our calibrated photodiode for each LED / fiber ;
 - **(2) Sparse Test Slit inside the spectrograph** : integrated flux measured on the CCD for the 3 arms of the spectrograph for each LED / fiber ;
 - **Ratio (1)/(2)** gives **throughput** (from fiber exit to the CCD included)



Integrated LED flux [e-/s] on the 3 CCDs

- For **each LED**, for **each fiber 11 – 20**, a **separate exposure**
- Frames are reduced (DESI pipeline), spectrum region is integrated
- CCD amplifier gains [ADU → e-] are applied
- Resulting CCD flux [e-] is then **divided by the effective exposure time**
- The resulting spectrum is **integrated on the whole arm wavelength range**

$$\phi_{[e-/s]}^{\text{CCD}} = \frac{\text{gain}_{[e-/ADU]}^{\text{ampli}} \times \sum_{\text{ill. pixels}}^{\text{spectrum}} \phi_{[ADU]}^{\text{CCD}} (\text{pixel})}{\Delta t_{[s]}^{\text{exposure}}}$$

We need to calibrate the exposure time and the CCDs amplifiers gains

